

G15 Engine

Safety, Operation, Maintenance & Parts Manual

LT15

rev. C3.01



Safety is our #1 concern! Read and understand all safety information and instructions before operating, setting up or maintaining this machine.

August 1997

Form #698

SECTION 1	SAFETY & GENERAL INFORMATION	1-1
1.1	Refueling	1-1
1.2	Engine Operation.....	1-1
SECTION 2	OPERATION	2-1
2.1	Starting The Engine.....	2-1
SECTION 3	MAINTENANCE	3-1
3.1	Air Filter & Pre-Cleaner.....	3-1
3.2	Engine Oil & Filter	3-1
3.3	Air Cooling System	3-1
3.4	Fuel Filter	3-2
3.5	Miscellaneous Maintenance	3-2
3.6	Drive Belt Adjustment.....	3-2
3.7	RPM Adjustments	3-4
SECTION 4	REPLACEMENT PARTS	4-1
4.1	How To Use The Parts List	4-1
4.2	Sample Assembly	4-1
4.3	Engine Assembly	4-2
4.4	Brake/Belt Tensioner Assembly.....	4-4
SECTION 5	ELECTRICAL DIAGRAM	5-1
5.1	Electrical Components, LT15G15.....	5-2

SECTION 1 SAFETY & GENERAL INFORMATION



IMPORTANT! This manual is provided as a supplement to the equipment manufacturer's manuals. This manual takes into account the specific use of engines on the Wood-Mizer sawmill. Only safety, maintenance, and operating procedures that are not provided by the manufacturer are supplied in this manual. Refer to the manufacturer's manual before attempting to operate this equipment.



This symbol calls your attention to instructions concerning your personal safety. Be sure to observe and follow these instructions. This symbol accompanies a signal word. The word **DANGER** indicates an imminently hazardous situation which, if not avoided, will result in death or serious injury. **WARNING** suggests a potentially hazardous situation which, if not avoided, could result in death or serious injury. **CAUTION** refers to potentially hazardous situations which, if not avoided, may result in minor or moderate injury to persons or equipment. Read all safety instructions before operating this equipment and observe all safety warnings!

1.1 Refueling



WARNING! Store gasoline away from sawdust and other flammable materials. Failure to do so may result in serious injury.

1.2 Engine Operation



DANGER! Always be sure the blade is disengaged and all persons are out of the path of the blade before starting the engine or motor. Failure to do so will result in serious injury.



WARNING! Do not for any reason adjust the engine drive belts or belt support bracket with the engine running. Doing so may result in serious injury.

WARNING! Remove the blade before performing any engine service. Failure to do so may result in serious injury.

WARNING! Always wear proper and necessary safety equipment when performing service functions. Proper safety equipment includes eye protection, breathing protection, hand protection and foot protection.



IMPORTANT! Always dispose of coolant, oil, fuel, oil filters and fuel filters in a responsible manner and in conformance with local, state and federal regulations.

SECTION 2 OPERATION

2.1 Starting The Engine

Engine Start



WARNING! Do not start the engine when the tensioner lever is in the ENGAGED (up) position. Always be sure the blade is disengaged and all persons are away from the sawmill before starting the engine.

1. Set and lock with the pin the tensioner lever in the ENGINE START position (middle position).

See Figure 2-1.

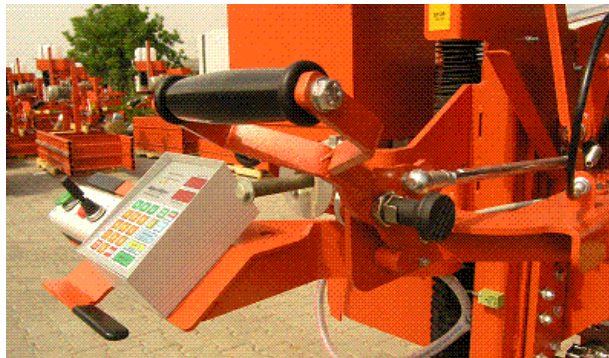

FIG. 2-1

2. Close the engine choke by moving the choke lever to the START position.

See Figure 2-2.

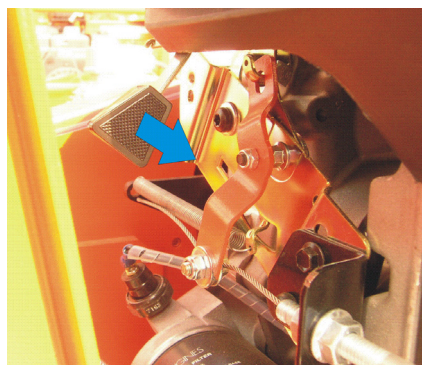

FIG. 2-2

3. Turn the key to the START position.

See Figure 2-3.



FIG. 2-3

4. When the engine is started, release the tensioner lever to the IDLING position and slowly open the choke by moving the choke lever to the OFF position.

See Figure 2-4.

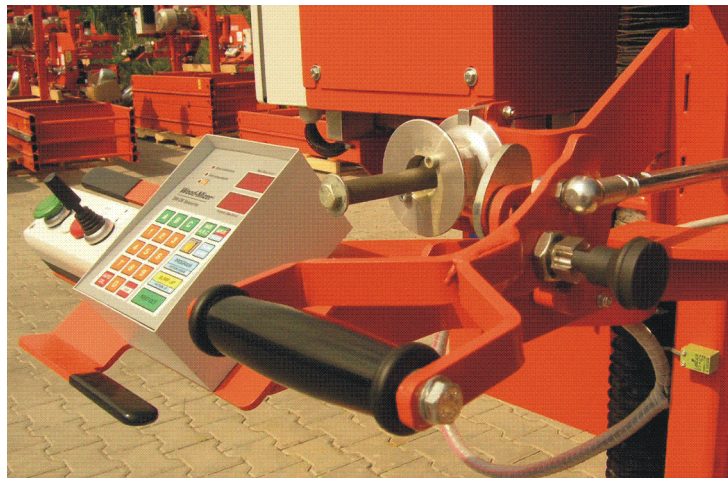

FIG. 2-4

5. To engage the blade, press and hold the green button on the control box and push the tensioner lever to the ENGAGED (up) position.

See Figure 2-5.

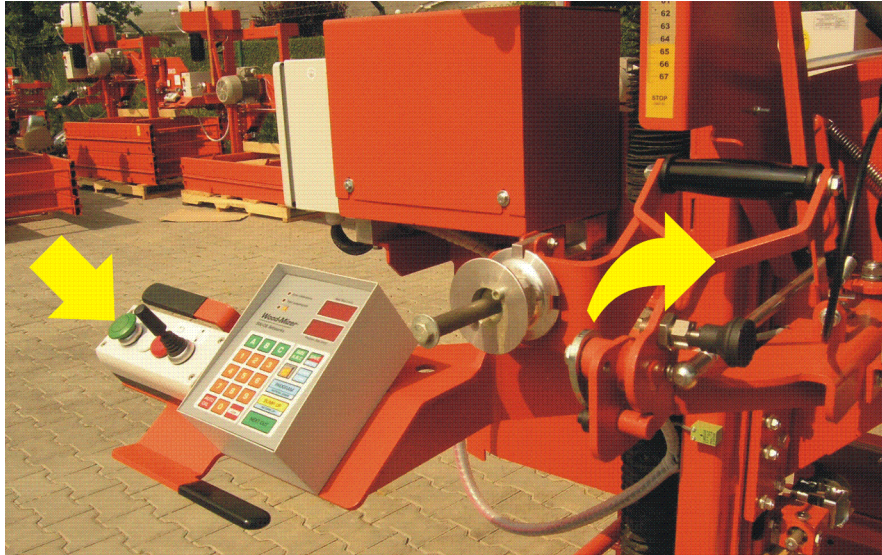

FIG. 2-5

Engine Shutoff

1. Disengage the tensioner lever to stop the blade (down position).
2. Let the engine run for 15 seconds without load and then turn the key to the OFF position.

SECTION 3 MAINTENANCE



IMPORTANT! This manual only provides information about additional procedures or procedures to be performed at different time intervals than found in the engine manufacturer's manuals. Refer to the [manufacturer's manual](#) for complete maintenance instructions.



WARNING! Remove the blade before performing any engine service. Failure to do so may result in serious injury.

 **This symbol** identifies the interval (hours of operation) which each maintenance procedure should be performed. "AR" signifies maintenance procedures which should be performed as required.

3.1 Air Filter & Pre-Cleaner



WARNING! Always wear proper and necessary safety equipment when performing service functions. Proper safety equipment includes eye protection, breathing protection, hand protection and foot protection.

 Service the pre-cleaner every four hours of operation. Service by gently shaking excess sawdust and debris from the foam piece.

 Clean the air filter (air cleaner element) and pre-cleaner (element wrapper) every eight hours of operation. See the engine manual for further instructions.

 Replace the air filter (cleaner) every 200 hours of operation.

 Replace the pre-cleaner (element wrapper) every 2000 hours of operation.

3.2 Engine Oil & Filter

 Check the oil level every 8 hours of operation. Add oil as necessary. See the engine manual for oil viscosity and grade recommendations.



IMPORTANT! During initial break-in, change the oil and the oil filter after the first 5 hours and every 50 hours thereafter. Continue to check oil level every 8 hours of operation and refill as necessary.



NOTE: Engine at factory is filled with 5W/40 Shell Helix Ultra, full synthetic oil.

3.3 Air Cooling System

 Wash the engine or brush off sawdust and debris every 50 hours of operation. Clean the grass screen, cooling fins, and external surfaces. Remove any dust, dirt or oil. See engine manual for further instructions.

3.4 Fuel Filter

Replace the fuel filter every 100 hours of operation.

100

3.5 Miscellaneous Maintenance

Inspect the spark plugs every 100 hour of operation. Remove any deposits and adjust gap if necessary. See engine manual for further information.

100

3.6 Drive Belt Adjustment



WARNING! Do not for any reason adjust the engine drive belts or belt support bracket with the engine running. Doing so may result in serious injury.

Check the drive belt tension after the first 20 hours, and every 50 hours thereafter.

50

The drive belt tension should be adjusted with the tensioner handle engaged (in the up position), by moving the engine assembly on the engine mount plate. To make the adjustment, perform the following steps:

1. Loosen the engine mounting bolts and the jam nuts.
2. Using the adjustment bolts, shown in the figure below, adjust the belt tension to approximately 11 mm deflection with 7.2 kG of deflection force.
3. Tighten the jam nuts and the engine mounting bolts.

See Figure 3-1.

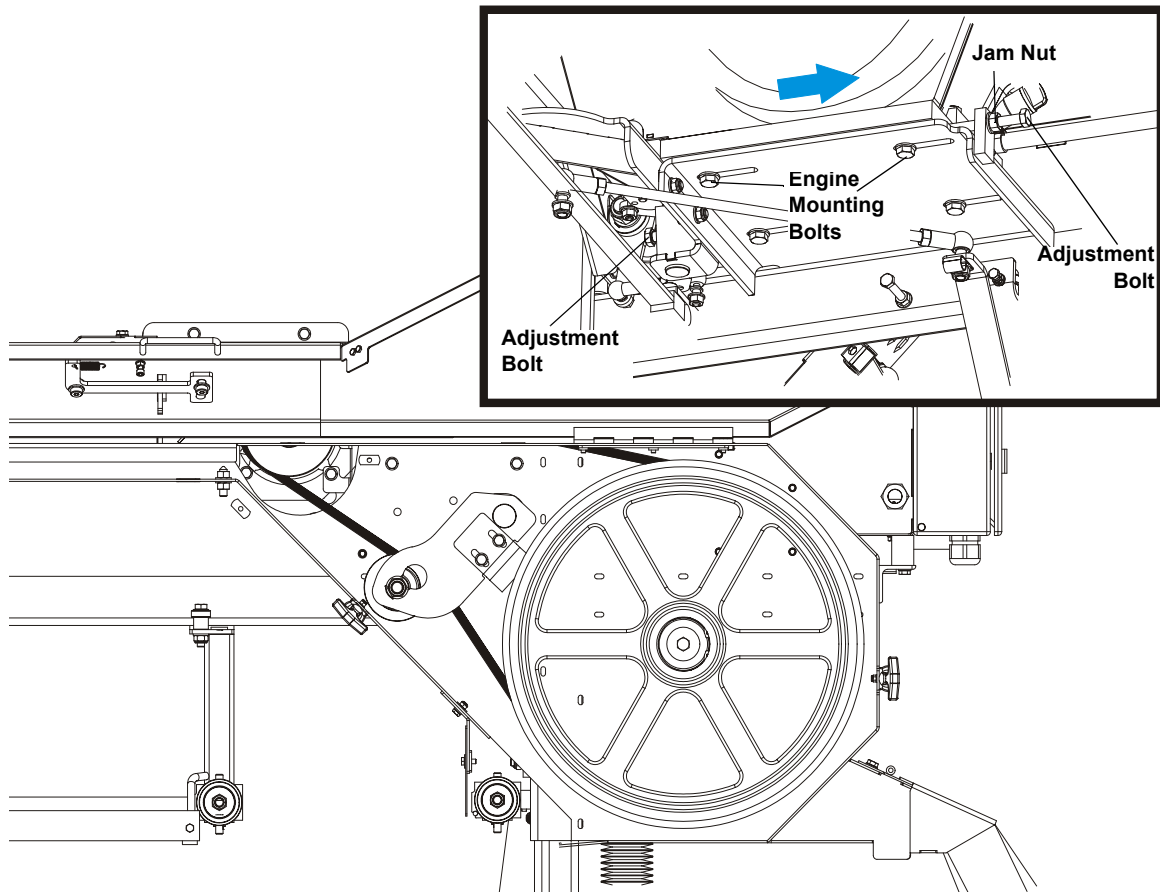

FIG. 3-1

Periodically check all belts for wear. Replace any damaged or worn belts as needed.

AR

3.7 RPM Adjustments



WARNING! Remove the blade before performing any engine service. Failure to do so may result in serious injury.

200 Check the RPM with a tachometer after the first 20 hours of operation and every 200 hours thereafter. High-end RPM should be 3650 (± 100) RPM and low-end RPM should be 1200 (not to exceed 1500).

Before checking the RPM, make sure belt and brake strap tension are correct (See Sawmill Maintenance).

1. Start the engine to measure the low-end RPM.

Make sure that the throttle linkage is not affecting the engine RPM while the clutch/brake handle is disengaged. Make sure the cable is not bent or kinked. Refer to the engine manual to adjust the low-end RPM.

2. Engage the clutch handle to throttle the engine and measure the high-end RPM. Readjust the throttle linkage if necessary to increase or reduce the high-end engine speed.

See Figure 3-2. The engine should start to throttle as soon as you start moving the clutch handle down. If the engine dies instead, restart the engine and adjust the throttle linkage as far as possible without affecting low-end RPM. **NOTE:** A properly adjusted throttle will extend the cable spring 1/4" to 3/8" (6.4 - 9.5 mm) when running and have a slight amount of slack in the cable when idling.

SECTION 4 REPLACEMENT PARTS

4.1 How To Use The Parts List

- Use the table of contents or the index to locate the assembly that contains the part you need.
- Go to the appropriate section and locate the part in the illustration.
- Use the number pointing to the part to locate the correct part number and description in the table.
- Parts shown indented under another part are included with that part.
- Parts marked with a diamond (◆) are only available in the assembly listed above the part.

See the sample table below. Sample Part #A01111 includes part F02222-2 and subassembly A03333. Subassembly A03333 includes part S04444-4 and subassembly K05555. The diamond (◆) indicates that S04444-4 is not available except in subassembly A03333. Subassembly K05555 includes parts M06666 and F07777-77. The diamond (◆) indicates M06666 is not available except in subassembly K05555.

4.2 Sample Assembly				
REF	DESCRIPTION (◆ Indicates Parts Available In Assemblies Only)	PART #	QTY.	
	SAMPLE ASSEMBLY, COMPLETE (INCLUDES ALL INDENTED PARTS BELOW)	A01111	1	
1	Sample Part	F02222-22	1	
	Sample Subassembly (Includes All Indented Parts Below)	A03333	1	
2	Sample Part (◆ Indicates Part Is Only Available With A03333)	S04444-4	1	◆
	Sample Subassembly (Includes All Indented Parts Below)	K05555	1	
3	Sample Part (◆ Indicates Part Is Only Available With K05555)	M06666	2	◆
4	Sample Part	F07777-77	1	

To Order Parts:

- From Europe call our European Headquarters and Manufacturing Facility in Kolo, Poland at **+48-63-2626000**. From the continental U.S., call **1-800-448-7881** to order parts. Have your customer number, vehicle identification number, and part numbers ready when you call.
- From other international locations, contact the Wood-Mizer distributor in your area for parts.

4.3 Engine Assembly

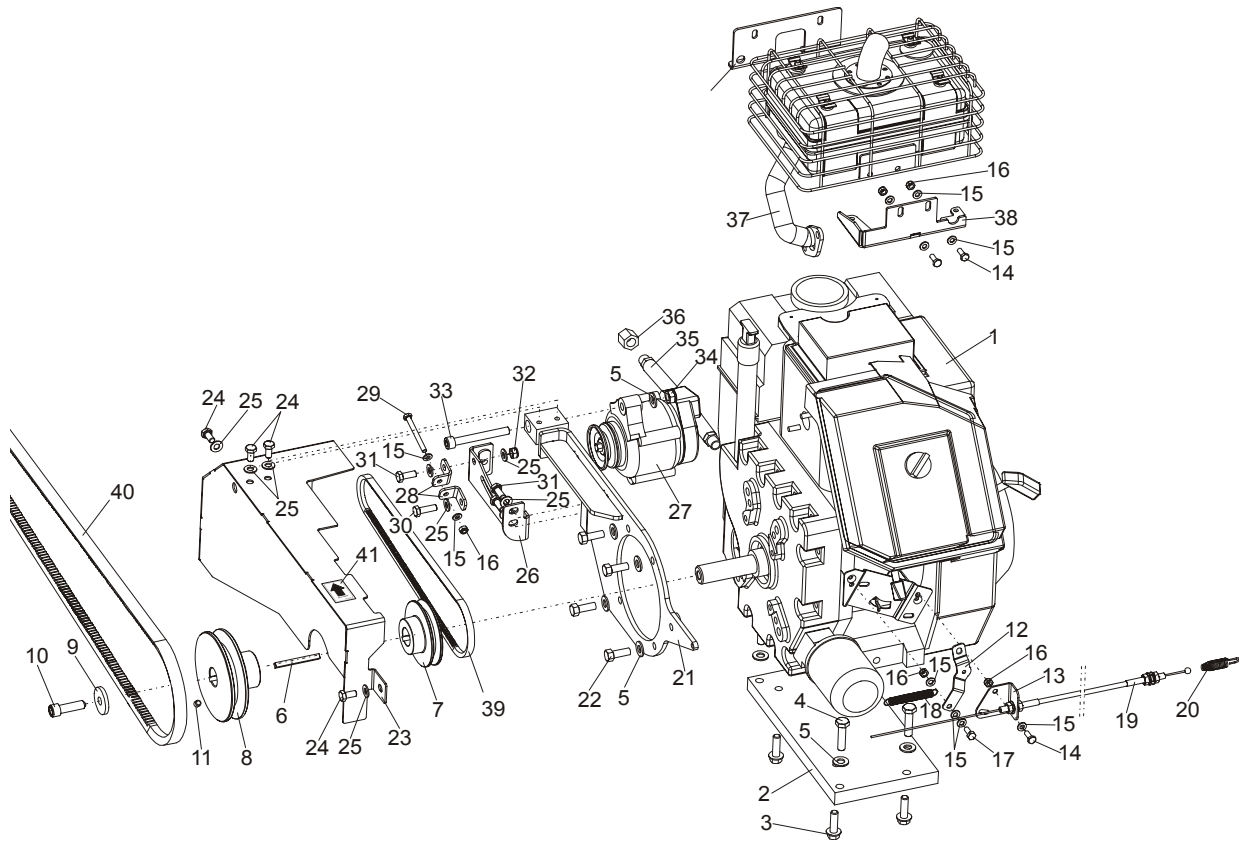

REF	DESCRIPTION (◆ indicates parts available in assemblies only)	PART #	QTY.
	ENGINE ASSY, LT15G15 KOHLER	096971	1
1	Engine KOHLER 15HP, CH15ST w/electric start	096443	1
	Filter, Kohler Air #47-083-01	014718	1
	Pre-Cleaner, Kohler Air #52-083-01	014719	1
	Filter, Kohler Oil #52-050-02	014717	1
	Plug, Kohler Spark #12-132-02 (Champion #RC12YC)	P12757	1
	Filter, Kohler In-Line Fuel #25-050-02	014720	1
2	Plate, G15 Engine Mounting	095297	1
3	Bolt, 3/8-16 x 1 1/4	F05007-131	4
4	Bolt, M10x40-8.8 Hex Head Full Thread Zinc	F81003-16	4
5	Washer, 10,5 Flat Zinc	F81055-1	9
6	Key, 6,35 x 6,35 x 63,5, Parallel Zinc	095334	1
7	Pulley, 30A Alternator	095267-1	1
8	Pulley, D10,G13,G15 - Engine Zinc	096447-1	1
9	Washer, G13 Kohler Engine, Zinc	088059-1	1
10	Screw, 7/16-20x1 1/2 SHC	F05007-55	1
11	Screw, M8x8-33H-Hex Socket Set Flat Point	F81014-1	1
12	Handle, Throttle Zinc	095300-1	1
13	Bracket, Throttle Cable Zinc	095301-1	1
14	Bolt, M6x16-8.8-Hex Head Full Thread Zinc	F81001-32	3
15	Washer, 6,4 Flat Zinc	F81053-1	10
16	Nut, M6-8-B-Hex Nylon Zinc Lock	F81031-2	5

17	Bolt, Throttle Cable Clamp Zinc-Plated	088120-1	1	
18	Spring, Extension 3/8X3	014818	1	
19	Cable, D10, LT15 Throttle	095308	1	
20	Spring, 35 x 9,5 x 1,6 Extension	097443	1	
21	Bracket, LT15/G15 Alternator	095302-1	1	
22	Screw, 3/8-16x1,HHC GR8	F05007-7	4	
23	Cover, LT15/G15 Alternator	095324-1	1	
24	Screw, M8x16 -8.8-B-Hex Head Full Thread Zinc	F81002-20	4	
25	Washer, 8,4-Flat Zinc	F81054-1	9	
26	Bracket, "Denso" 30A Alternator	095268-1	1	
27	Alternator D42	089661	1	
28	Tensioner, 30A Alternator Belt	095296-1	1	
29	Bolt, M6x60-8.8-Hex Head Full Thread Zinc	F81001-9	1	
30	Bolt, M8x25-8.8-B-Hex Head Full Thread Zinc	F81002-5	1	
31	Bolt, M8x20-8.8-B-Hex Head Full Thread Zinc	F81002-4	3	
32	Nut, M8-8-B-Hex Nylon Zinc Lock	F81032-2	1	
33	Screw, M10x80 -8.8 Hex Socket Head Cap Zinc	F81003-69	1	
34	Nut, M10-8-B -Hex Nylon Zinc Lock	F81033-1	1	
35	Hose, Rubber	P10082	1	
36	Cap, 3/8 Pipe Galvanize	P04332	1	
37	Muffler, G13 Engine	088313-1	1	
38	Bracket Weldment, G13 Muffler Support Ptd	088310-1	1	
39	Belt, AVX10x838La	095329	1	
40	BELT, 17BX 2250 REF. BX87, 2210Li (GOOD-YEAR)	097448	1	
41	DECAL, 3600 RPM ENGINE DIRECTION	S20097A ¹	1	

¹ Included in 099421 - LT15DC Pictographic Decal Kit.

4.4 Brake/Belt Tensioner Assembly

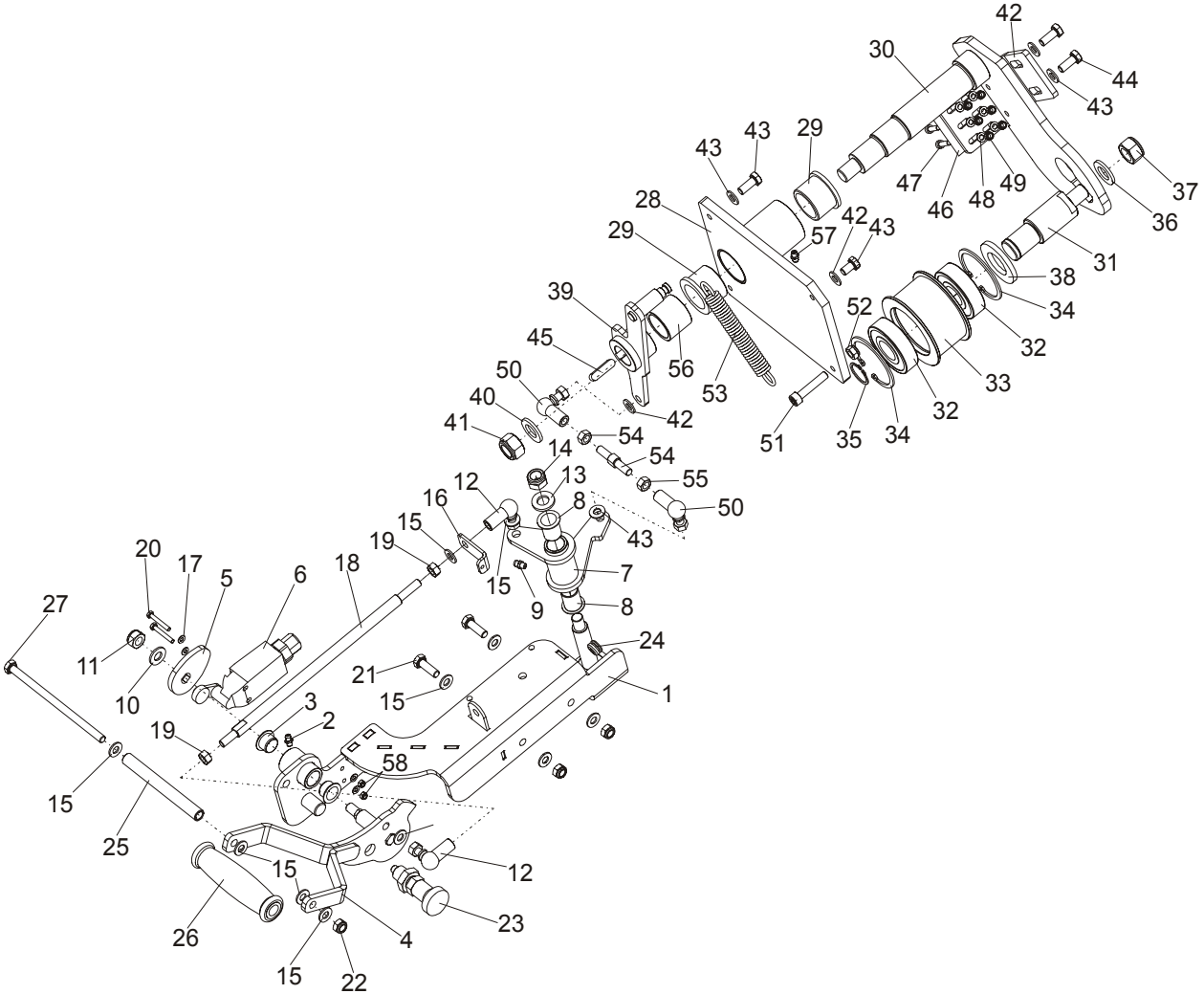

REF	DESCRIPTION (◆ Indicates Parts Available In Assemblies Only)	PART #	QTY.
	BELT TENSIONER & BRAKE ASSEMBLY	096448	1
	HANDLE, TENSIONER AND BRAKE COMPLETE	097436	1
	Plate, Tensioner/Brake Handle Complete	097437	1
1	Plate, Tensioner/Brake Handle	097438-1	1
2	Fitting, M6 Type A Grease	086280	1
3	Bushing, GFM - 1618-12 Igus	091455	2
4	Grip, Tensioner/Brake Handle	095318-1	1
5	Cam, LT15 Limit Switch Zinc	096969-1	1
6	Limit Switch, EVN2000 A	091742	1
	Angle Lever, Complete	097432	1
7	Lever, Angle	097433-1	1
8	Bushing, GFM 1719-25	094142	2
9	Fitting, M6 Type A Grease	086280	1
10	Washer, 10,5 Flat Zinc	F81055-1	1
11	Nut, M10-8-B Hex Nylon Zinc Lock	F81033-1	1
12	Pivot, FI 13-M8 (T17628-ULMER) Angle	095285	2

13	Washer, 13 Flat Zinc	F81056-1	1	
14	Nut, M12-8 Hex Nylon Zinc Lock	F81034-2	1	
15	Washer, 8,4 Flat Zinc	F81054-1	11	
16	Plate, Tensioner	097442-1	1	
17	Washer, 4,3 Flat Zinc	F81051-2	4	
18	Pusher, M8 Long	097444-1	1	
19	Nut, M8-8-B Hex Zinc	F81032-1	2	
20	Bolt, M4x30 8.8 Hex Head Full Thread Zinc	F81011-5	2	
21	Bolt, M8x25-8.8-B Hex Head Full Thread Zinc	F81002-5	2	
22	Nut, M8-8-B Hex Nylon Zinc Lock	F81032-2	3	
23	Pin, 45308DNW Detent	089939	1	
24	Seal Wire, Rubber Inside Dia 6mm	085338	1	
25	Axle, Grip Rotation	097698-1	1	
26	Knob, 1.135/120-13 Crank Handle	097696	1	
27	Bolt, M8x150-8.8 Hex Head Zinc	F81002-36	1	
	TENSION ROLLER W/BRAKE, COMPLETE	097446	1	
28	Mount Wldmt, Tensioner Shaft Ptd	091112-1	1	
29	Bushing, MFM-3240-30 (IGUS)	088461	2	
30	Shaft, Belt Tensioner	096451-1	1	
	Roller, Tension Complete	097832	1	
31	Axle, Belt Tension Wheel Zinc	100232-1	1	
32	Bearing Wheel, Idle Side 6305 2RS NSK.	P08066	2	
33	Wheel, LT15 Belt Tension Zinc	087671-1	1	
34	Ring, 62W Inside Spring Retaining	F81090-1	2	
35	Ring, 25Z Outside Retaining	F81090-22	1	
36	Washer, 17 Flat Zinc	F81058-1	1	
37	Nut, M16-8-Hex Nylon Zinc Lock	F81036-2	1	
38	Washer, Tension Roller Axle, Zinc	100237-1	1	
39	Lever, Tensioner Double-Arm	096449-1	1	
40	Washer, 17 Flat Zinc	F81058-1	1	
41	Nut, M16-8-Hex Nylon Zinc Lock	F81036-2	1	
42	Bracket, Brake Block Mount Ptd	091248-1	1	
43	Washer, 8,4-Flat Zinc	F81054-1	7	
44	Bolt, M8x20-5.8-Hex Head Full Thread Zinc	F81002-1	5	
45	Key, A8x7x32 Parallel	088564	1	
46	Block, F9273 123 Drive Belt Tensioner Brake	092111	2	
47	Screw, M5x25-8.8-Hex Socket Head Cap Zinc	F81000-7	6	
48	Washer, 5,3 Flat Zinc	F81052-1	6	
49	Nut, M5-8-DIN 985 Zinc	F81030-2	6	
50	Pivot, FI 13-M8 (T17628-ULMER) Angle	095285	2	
51	Screw, M8x40 -8.8- Hex Socket Head Cap Zinc	F81002-29	1	
52	Nut, M8-8-B-FeZn5 Hex Nylon Zinc Lock	F81032-2	1	
53	Spring, FI 1,9 x fi 14,2 x 104	091865	1	
54	Pusher, Short Zinc	097445-1	1	
55	Nut, M8-8-B-Hex Zinc	F81032-1	2	
56	Bushing, Tensioner Zinc	097447-1	1	
57	Fitting, M6 Type A Grease	086280	1	
58	Nut, M4-B-Hex Zinc	F81029-1	2	

SECTION 5 ELECTRICAL DIAGRAM

See Figure 5-1. See the figure below for the electrical diagram of the LT15 sawmill with G15 gas engine and SW-08 Networks.

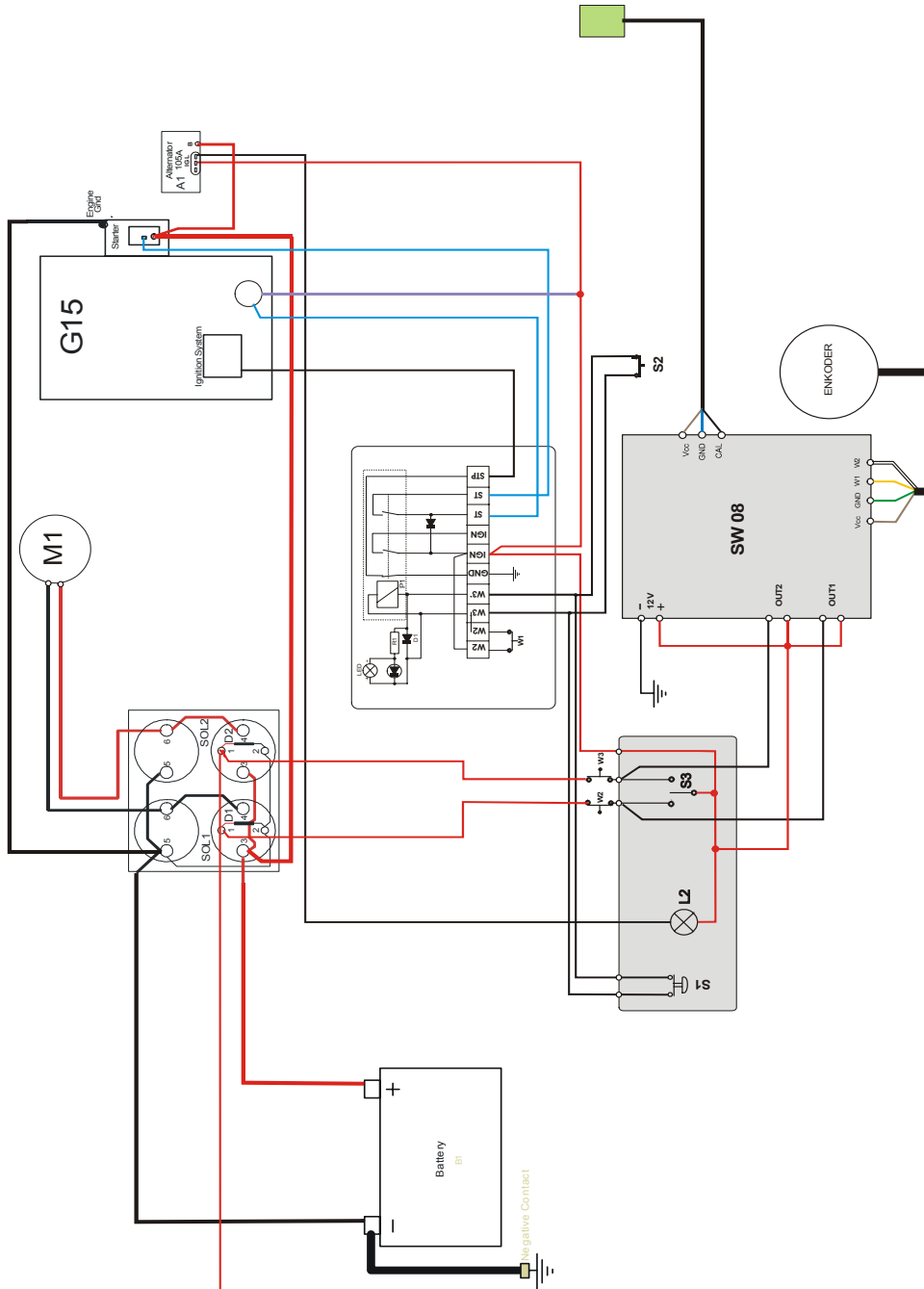

ABB. 5-1

5.1 Electrical Components, LT15G15

Symbol	Wood-Mizer Part No.	Description
B1	091775	Battery, 36Ah
S1	094328	Button, M22 Momentary Mushroom Green
Pk1	086486	Relay, D9120 IP 65/64
W1	094232	Safety switch - Guard
W2, W3	100910	Safety Switches, Up/Down
L1	091051	Light, KLA-GS-10-2 Control
SOL1	092803	Valve, ET-3 12V Fuel Solenoid
S3	095332	Joystick, 2-position Up/Down
S2	100931	Limit Switch, GLCB01A1B
L2	095331	Control Light

TABELA 5-1