



user manual

Instrukcja obsługi | Руководство пользователя
Manuel de l'Utilisateur | Betriebsanweisung
Bruksanvisning | Manual del Usuario
Betjeningsvejledning | Gebruikershandleiding
Käyttöohjeet | Manual de utilizare | Bruksanvisning
Manuale d'uso | Příručka uživatele | Navodila
za uporabo

Retain for future use
Zachować do przyszłego użytku
Сохраните для последующего
использования
A conserver pour une utilisation future
Für zukünftige Benutzung aufbewahren
Behold for senere bruk
Säilytä nämä käyttöohjeet tulevaa tarvetta marten
Opbevar manualen til fremtidig brug
Bewaren voor gebruik in de toekomst
Conservare il presente manuale a l'uso futuro
Păstrați acest manual pentru utilizare viitoare
Conservar para futuras consultas
Behall för framtida användning
Uchovejte pro další použití
Hranite za prihodnjo uporabo

SW-08 NETWORKS

Operation & Parts Manual

LT20 SW-08 Networks
LT40 SW-08 Networks

rev.B.00
rev. B.00



Safety is our #1 concern! Read and understand all safety information and instructions before operating, setting up or maintaining this machine.

Form #643

Table of Contents

Section-Page

SECTION 1	OPERATION	1-1
1.1	SW-08 Controller Panel	1-1
1.2	Start-up settings of the controller	1-3
1.3	Operation in normal mode.....	1-6
1.4	Controller operation in pre-defined head return height mode	1-8
1.5	Pattern Mode	1-9
SECTION 2	TROUBLESHOOTING GUIDE	2-1
2.1	Setworks Malfunction	2-1
SECTION 3	REPLACEMENT PARTS	3-1
3.1	How To Use The Parts List	3-1
3.2	Sample Assembly	3-1
3.3	LT20 SW-08 Setworks	3-2
3.4	LT40 SW-08 Setworks	3-4

SECTION 1 OPERATION

1.1 SW-08 Controller Panel

See Pic. 1-1.

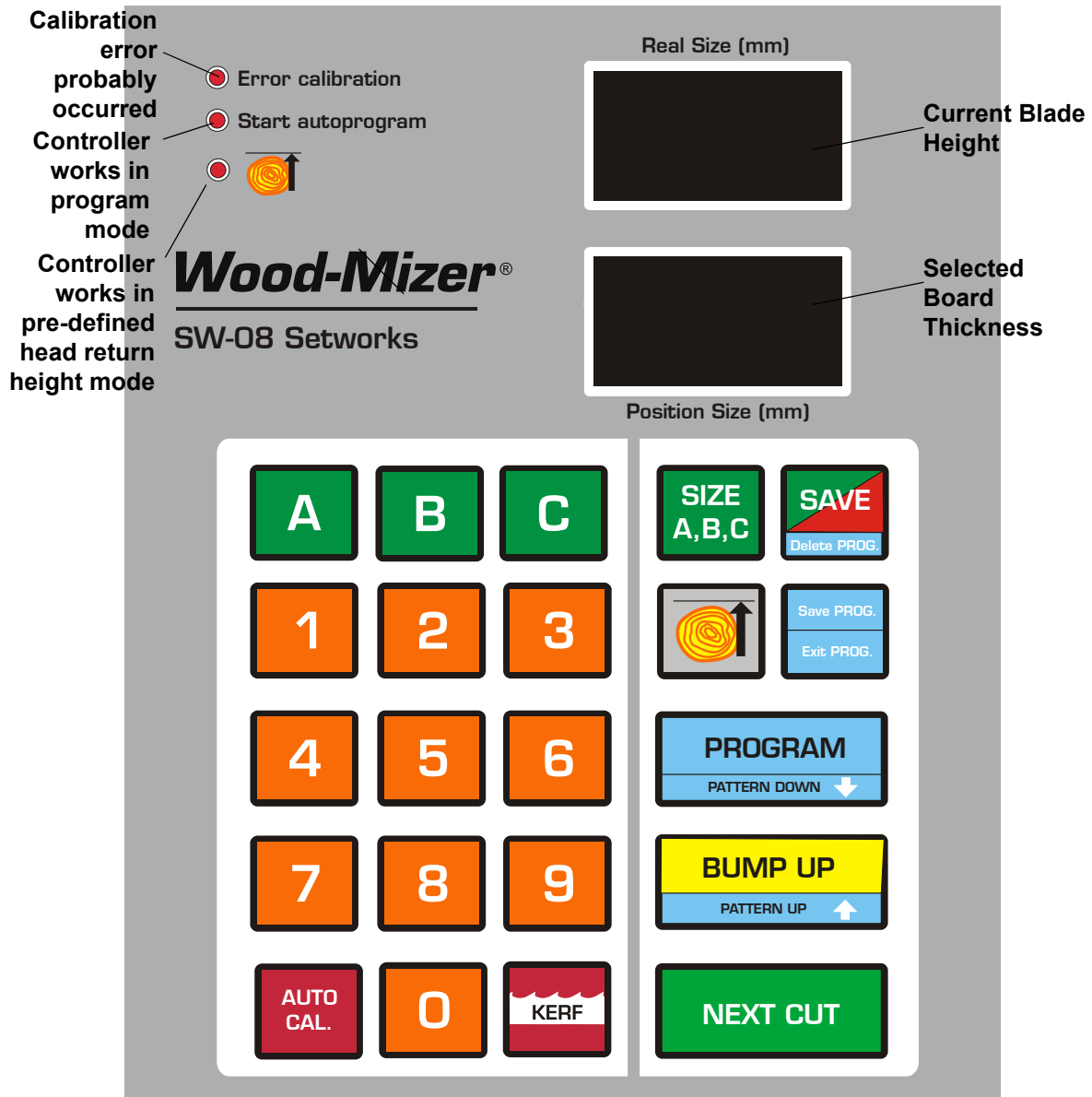

PIC. 1-1

1 OPERATION

SW-08 Controller Panel

Descriptions of the control panel buttons:



A, B, C - Board thickness memory buttons.



Size A, B, C - Changing the boards thickness values stored in the controller memory.



SAVE/Delete PROG. - Saves various parameters or deletes the user program.



Save Ref. - Saves head return height determined by operator.



Save PROG. / Exit PROG. - Confirming or exiting the user program.



PROGRAM / PATTERN DOWN– Programming/entering the existing program.



BUMP UP / PATTERN UP - Bump Up. Automatically moves the saw head up to clear the log or cant when it is returned. The Bump Up value is factory-set and can not be changed by a user.



NEXT CUT– The saw head automatically moves down to the next cut.





KERF – Setting the kerf.



Auto Cal – Adjustment of the SW-08 automatic calibration parameters. Also used for initial calibration and re-calibration if a dimensional error occurs.

1.2 Start-up settings of the controller

1. Setting the input divider (entered only once, at the first start-up)

- Switch on the controller.
- When the text “ISP-08” appears on the display, press and hold , until the divider value appears on the lower display.
- Enter the correct value of the divider (depending on the up/down system of the machine) using the keypad (for LT15 sawmills, the divider value should be **20**, for LT20 and LT40 sawmills, the divider value should be **5**).
- Press  to save the entered divider value.

2. Entering the blade kerf thickness

On initial start-up or after replacement of the blade with another one with a different thickness or different tooth set, the kerf value should be entered.

- Press and hold , until the small zero and current kerf settings appear on the lower display.
- Enter the kerf value.

NOTE: We recommend using the Wood-Mizer blades only. For the Wood-Mizer blades, the kerf value should be 2mm, so you should press “2” and “0” buttons.

SW-08 Networks can accept kerf value with an accuracy of 0,1 mm.

1 OPERATION

Start-up settings of the controller

See Pic. 1-2.

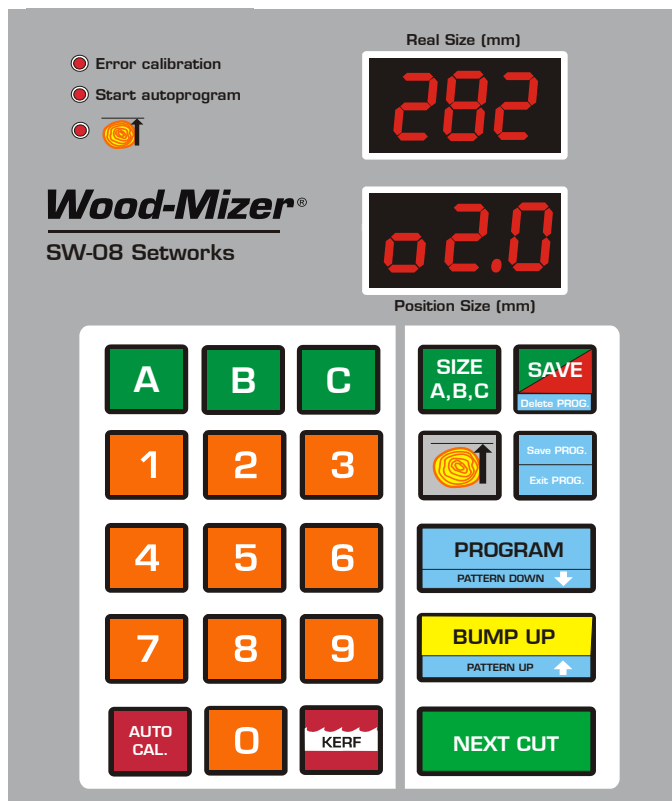

PIC. 1-2

- Press  to save the setting. The controller displays the text “**SAVE**” and exits the function.

NOTE: From this moment the Networks controller will be calculating the cutting position using the kerf value. Therefore, it is not necessary to correct the head height manually during cutting.

3. Auto-calibration

This function should be used in case of:

- [LT15 sawmills] Replacement of the up-down system screw, motor or after lubrication of the screws and other moving elements of the head or when significant cutting variances are observed;



- [LT20 and LT40 sawmills] If the divergence between the blade height shown on the upper display and the real dimension from the bed rail level is observed.

- Switch on the controller and wait until the text “ISP-08” disappears.
- Set the head with the blade at the height of 130 mm.
- Press and hold down . After a while - the text “**Auto CALL**” will appear on the display. The controller is ready for auto-calibration.

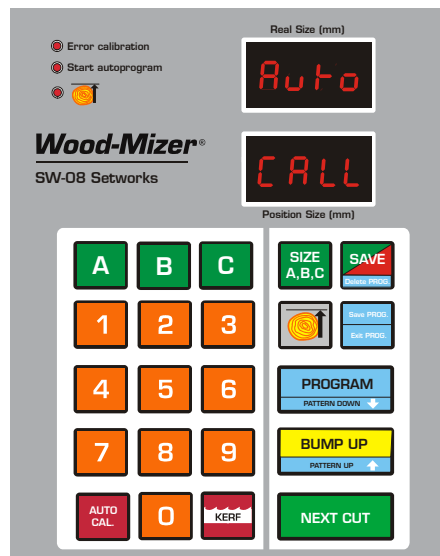
See Pic. 1-3.



PIC. 1-3

- Press , the controller successively performs 9 upward movements of the head and then, 1 downward movement and 1 upward. After performing the last movement, the text “**Auto**” will appear on the upper display and the current blade height will appear on the lower display. Check if the height value is correct using the sawmill scale or measure the distance between the sawmill bed and the blade. If it is correct, press , if not enter the correct blade height using the keypad and press .

1 OPERATION

Operation in normal mode

- The end of the function is signalled and the normal mode of operation is restored.

NOTE: Enter the height with an accuracy of 0,1 mm. For example: if you want to enter 140mm - press 1-4-0-0 without any pauses.

NOTE: If during the downward movement the saw head hits the stop bolt, set the head a little higher than previously and repeat the auto-correction function.

NOTE: After each controller startup the **Error calibration** lamp blinks to indicate that the controller might lose its settings when the power was off. Also, during normal operation the calibration error may occur. If the auto-calibration procedure has already been done, move the saw head down to the height of 130mm and next move it up to the height of 150mm. During this procedure the calibrating sensor is passing the calibrating point, and the controller corrects the readings of the saw head position.



NOTE: To provide the maximum cutting accuracy, it is recommended to perform the auto-calibration procedure on every controller startup.

1.3 Operation in normal mode



CAUTION! The minimum thickness of the last board (when using the automatic modes) cannot be lower than **30 mm** [LT15 and LT20 sawmills] or **50mm** [LT40 sawmills]. To cut a thinner board, you need to manually lower the saw head.

After switching-on, the "ISP-08" inscription appears on the display, and the Setworks is ready for operation within a few seconds. The last used board thickness is displayed.



- To change the board thickness, enter the new thickness required using the keypad. Press . The saw head will move down by the pre-set value (board thickness + kerf).
- You can store up to three thicknesses of boards in the controller memory. To store the board thickness, press and hold , next press the memory button you want to use (A, B or C). Enter the required board thickness using the keypad and

confirm by pressing . Now you can use the stored thicknesses of boards by pressing A, B or C buttons.

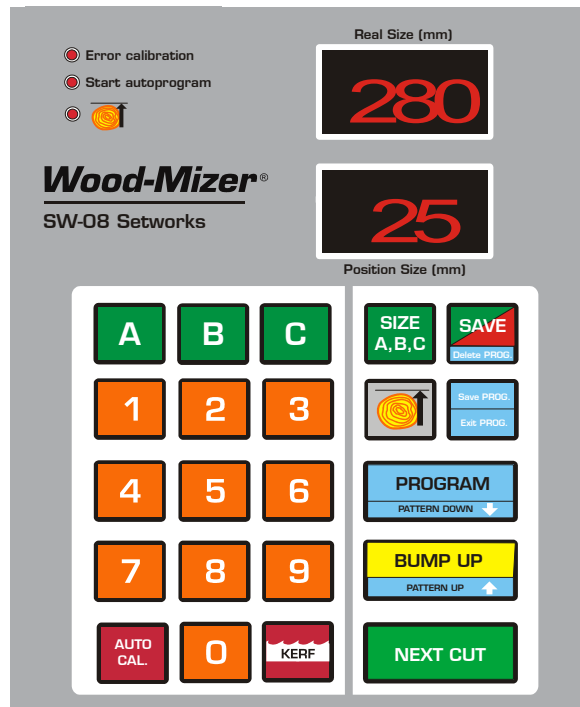
See Pic. 1-4.



PIC. 1-4

- Start to cut material of required dimension.
- Remove the board.
- Having completed a cut, press , the head will automatically go up by the Bump Up value, allowing the head to return with the blade clear of the log or cant.
- Press  and the saw head will drop by the pre-set board thickness to **the next cut position**.

The first cut position has to be set manually.

NOTE: After you set the first cut position you do not need to set the head height manually.

1 OPERATION

Controller operation in pre-defined head return height mode

1.4 Controller operation in pre-defined head return height mode

It is possible to program a head return height. This is particularly useful if you are cutting “through and through” and do not want to remove each board after cutting.



Programming a head return height:

- Position the head above the cant or log so that it will clear the cant.
- Press and hold  until the lamp shown on the picture below starts lighting.

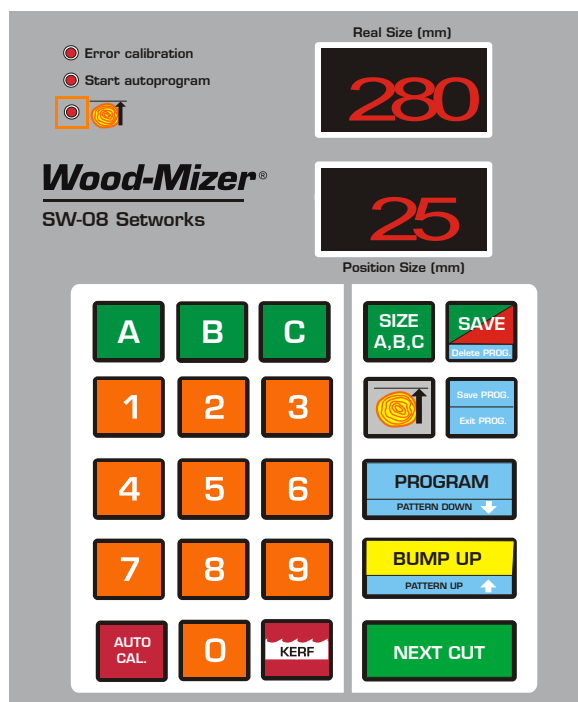
See Pic. 1-5.



PIC. 1-5

- Choose the board thickness and press  .
- Now, when you press  after each cutting, the head will go up to the saved height and clear the log or cant.

- Press  and the saw head will drop by the pre-set board thickness to **the next cut position**.

Press and hold  to return to normal Bump Up operation.

1.5 Pattern Mode





Use this function when you want to create a series of cuts calculated up from the bed level.

This function can be used in two different ways.

You can create a pattern of the same thickness of boards.



You can create your own pattern, for instance a 100mm final board preceded by a 50mm board and then 25 mm boards.

Using the Pattern Mode when you want to cut boards of the same thickness

- Position the head a little above the log.
- Store the required board thickness under one of the memory buttons (**A**, **B** or **C**) ([See Section 1.3](#)).
- Press and hold the board thickness memory button (**A**, **B** or **C**) with the required board thickness to activate the Pattern Mode.
- For a moment the text “**FULL**” and next **P90** will appear on the upper display.
- Press . The controller will calculate how many boards of the required thickness can be cut and will move the saw head to the first cut position below the current head position. If you need to change this position, you can do this using  or . When you press one of these buttons, the controller will calculate another cut position above or below the previously calculated position, taking into account the required board thickness. When you press , the saw head will move to this position. When you accept the position of the first cut, press . The text “cut” will appear indicating that you can start cutting.
- If you are going to cut “through and through” and do not want to remove each board

1 OPERATION

Pattern Mode







after cutting, position the head above the log using the up/down switch so that it clears the log along the entire length. Press and hold . Next, press  and the saw head will move to the accepted first cut position.

- Cut the material using  and  as in Normal Mode ([See Section 1.3](#)).
- After cutting the last board, **End pro** will be shown to indicate the end of cutting.



NOTE: If you need to exit *Pattern Mode* before finishing cutting, press .



Using the Pattern Mode when you want to get boards of different thicknesses

[Entering a new program into the controller memory](#)



- To enter the programming mode, press and hold . Delete the existing program by pressing and holding . The text “**Clr**” confirms that the program has been deleted.
- Using **A**, **B** or **C** buttons or the keypad, enter the first board thickness value (first from the sawmill bed). To confirm and enter the next board thickness, press . You can enter up to 90 different board thicknesses. When entering particular thickness values, you can any time switch between the program positions using  and  and correct these values.
- When all requested boards thickness values are entered, save the program using .



[Using the entered program](#)

- Position the head a little above the log.
- Press and hold  to activate the Pattern Mode.
- Press . The controller will calculate and move the saw head to the first cut position.

- If you need to change this position, you can do this using  and  buttons. When you press one of these buttons and confirm by pressing , the controller will move the saw head to the previous or next position from the program.

- If you accept the position of the first cut, press . The text “cut” will appear indicating that you can start cutting.

- If you are going to cut “through and through” and do not want to remove each board after cutting, position the head above the log using the up/down switch so that it clears the log along the entire length. Press and hold . Next, press  and the saw head will move to the accepted first cut position.

- Cut the material using  and  as in Normal Mode ([See Section 1.3](#)).

- After cutting the last board, **End pro** will be shown to indicate the end of cutting.













NOTE: If you need to exit *Pattern Mode* before finishing cutting, press .

1 OPERATION

Pattern Mode

Example:

In this example we have a log with three sides flat and we want to finish with a 100mm x 100mm cant and get three boards - 50mm, 28mm and 25mm. "Through and through" cutting procedure will be described.

- To enter the programming mode, press and hold . Delete the existing program by pressing and holding . The text "Clr" confirms that the program has been deleted.
- Using the keypad, enter the first board thickness value (100) and press . Enter the next board values (50, 28 and 25mm), each time confirm by pressing . Press  to save the program.
- Position the head a little above the log.
- Press and hold  to activate the Pattern Mode.
- Press . The controller will calculate and move the saw head to the first cut position.
- Press  to accept the position of the first cut. The text "cut" will appear indicating that you can start cutting.
- Position the head above the log using the up/down switch so that it clears the log along the entire length. Press and hold . Next, press  and the saw head will move to the accepted first cut position.
- Cut the material using  and  as in Normal Mode. ([See Section 1.3.](#))
- After cutting the last board, **End pro** will be shown to indicate the end of cutting.

- Remove the boards.

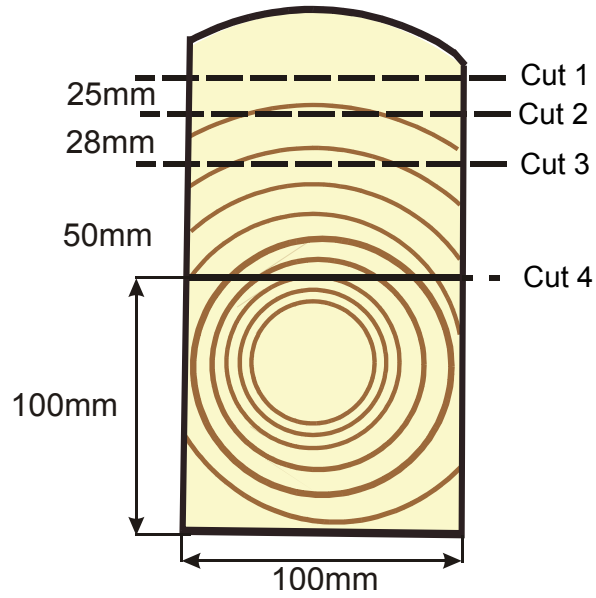

PIC. 1-6

SECTION 2 TROUBLESHOOTING GUIDE

2.1 Networks Malfunction

PROBLEM	CAUSE	SOLUTION
Setworks does not work	Magnet sensor improperly aligned	Locate the magnet sensor and align it as shown on pictures 2-1 and 2-2. Calibrate the network controller. See Section Auto-calibration.
Setworks controller calculates the dimensions of boards incorrectly	Improper input parameters	<ul style="list-style-type: none"> - Check the input divider and the kerf settings (See Section Setting the input divider (entered only once, at the first start-up) and See Section Entering the blade kerf thickness). - Perform the auto-calibration procedure. See Section Auto-calibration.
During the auto-calibration procedure the Setworks controller stops the saw head and the text “Err Call” appears.	Controller doesn't receive the calibration sensor signal or the signal is bad.	<ul style="list-style-type: none"> - Check if the LED lamp on the calibration sensor illuminates when the plate on the saw head mast is passing the calibration sensor. See Picture 2-3 or 2-4. - Check if the plate on the saw head mast is not too far from the calibration sensor (distance between the plate and the sensor should be 2-4mm).
Saw head does not stop at the required blade height, but goes up or down until it hits the stop bolt or the upper limit switch is activated.	Setworks controller not calibrated	Check the input divider and the kerf settings. Calibrate the the Setworks controller.

Setworks controller stops the saw head and the text "Err PULS" appears.

Blade height sensor signal is bad

- Check the connections between the blade height sensor and the controller.
- Check if the encoder or the magnetic strip (depending on the machine) is not loose.
- Check condition of the encoder clutch (LT15 sawmills only).
- Check if the connections to the sawmill up/down system contactors are correct and not loose.

During manual downward movement the upper display shows a negative blade height value

Setworks controller not calibrated

Calibrate the Setworks controller.

When pressing  during normal operation or when attempting to save the program

The lower blade height limit would be exceeded if the requested saw head movement was performed.

Try to enter a lower board thickness value.

(using  button), the upper display shows horizontal dashes

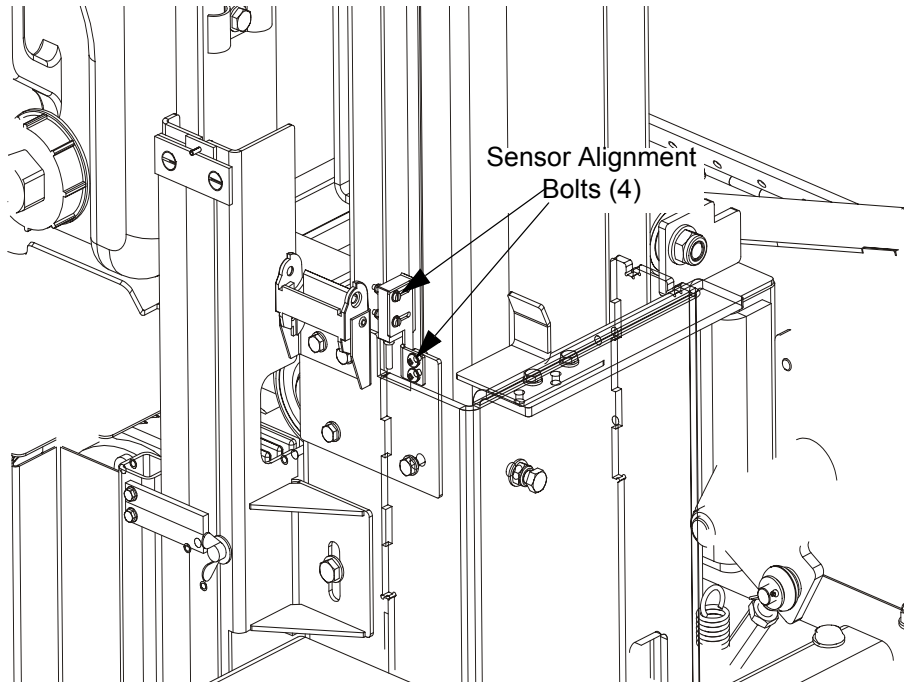

FIG. 2-1

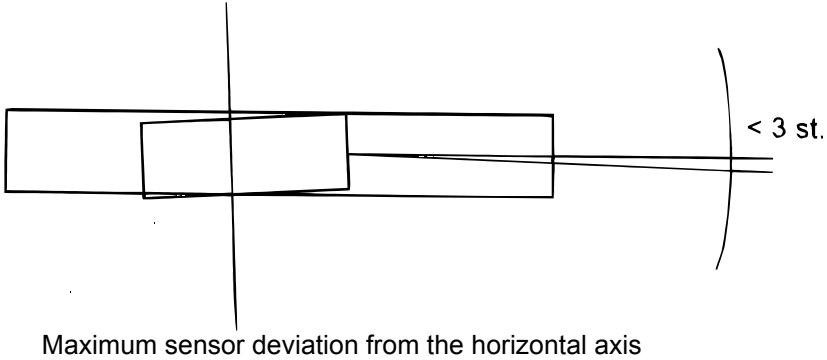
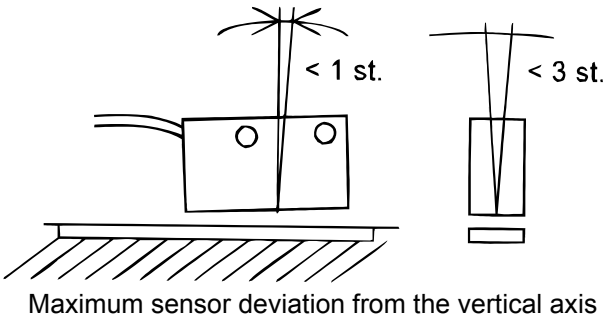
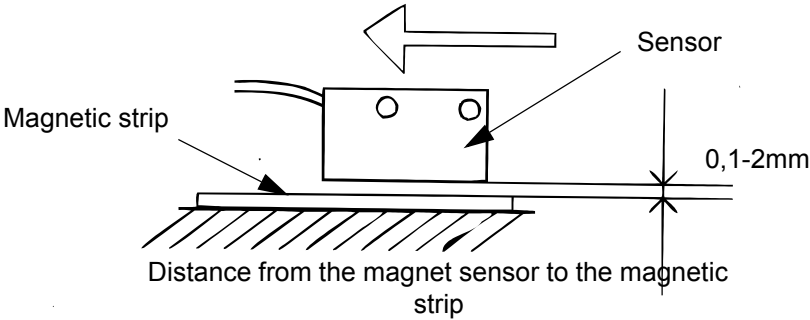

FIG. 2-2

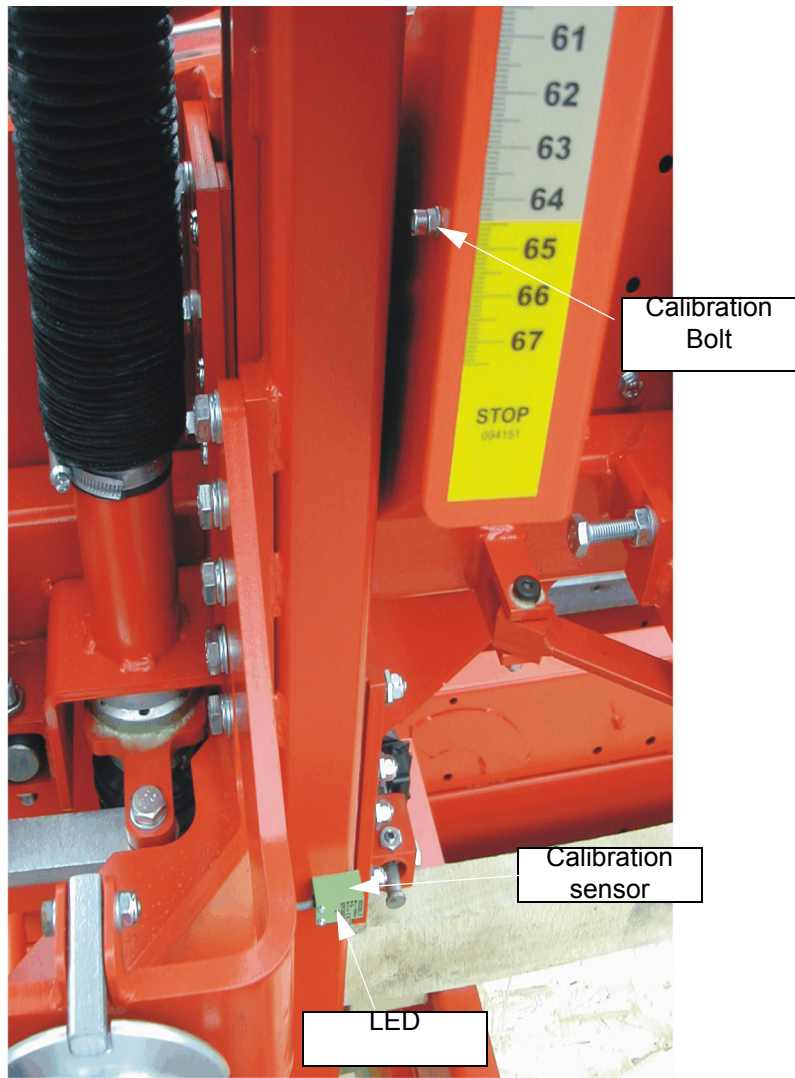

FIG. 2-3 LT15

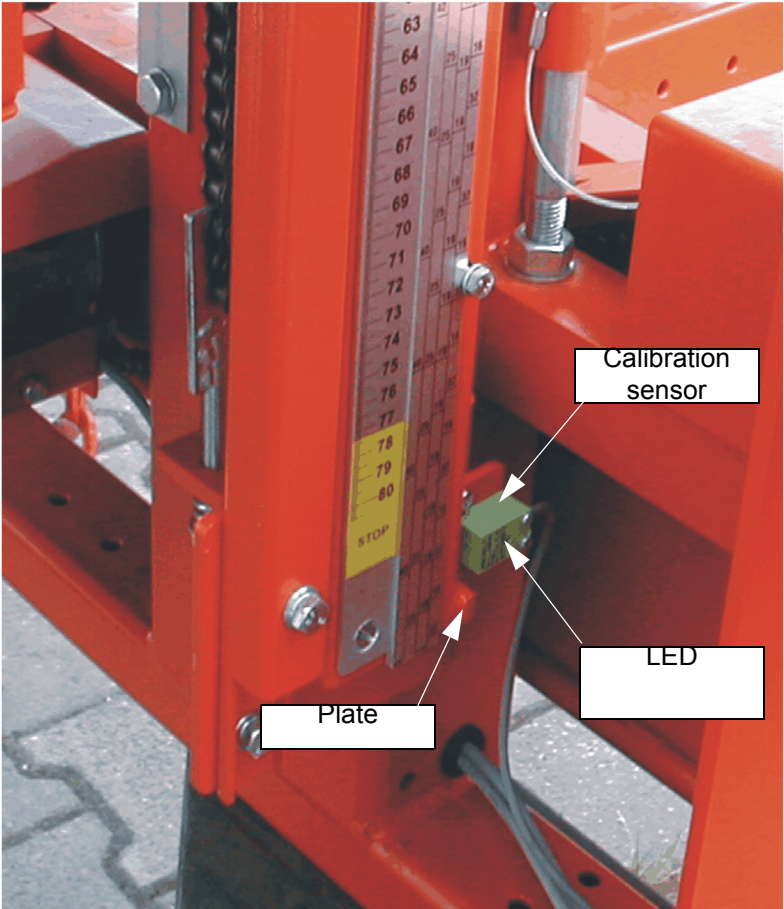

FIG. 2-4 LT20

SECTION 3 REPLACEMENT PARTS

3.1 How To Use The Parts List

- Use the index above to locate the assembly that contains the part you need.
- Go to the appropriate section and locate the part in the illustration.
- Use the number pointing to the part to locate the correct part number and description in the table.
- Parts shown indented under another part are included with that part.
- Parts marked with a diamond (◆) are only available in the assembly listed above the part.

See the sample table below. Sample Part #A01111 includes part F02222-2 and subassembly A03333. Subassembly A03333 includes part S04444-4 and subassembly K05555. The diamond (◆) indicates that S04444-4 is not available except in subassembly A03333. Subassembly K05555 includes parts M06666 and F07777-77. The diamond (◆) indicates M06666 is not available except in subassembly K05555.

3.2 Sample Assembly				
REF	DESCRIPTION (◆ Indicates Parts Available In Assemblies Only)	PART #	QTY.	
	Sample Assembly, Complete (Includes All Indented Parts Below)	A01111	1	
4	Sample Part	F02222-22	1	
	Sample Subassembly (Includes All Indented Parts Below)	A03333	1	
5	Sample Part (◆ Indicates Part Is Only Available With A03333)	S04444-4	1	◆
	Sample Subassembly (Includes All Indented Parts Below)	K05555	1	
6	Sample Part (◆ Indicates Part Is Only Available With K05555)	M06666	2	◆
7	Sample Part	F07777-77	1	

To Order Parts:

- From Europe call our European Headquarters and Manufacturing Facility in Kolo, Poland at **+48-63-2626000**. From the continental U.S., call our toll-free Parts hotline at **1-800-448-7881**. Have your customer number, vehicle identification number, and part numbers ready when you call.
- From other international locations, contact the Wood-Mizer distributor in your area for parts.

3.3 LT20 SW-08 Setworks

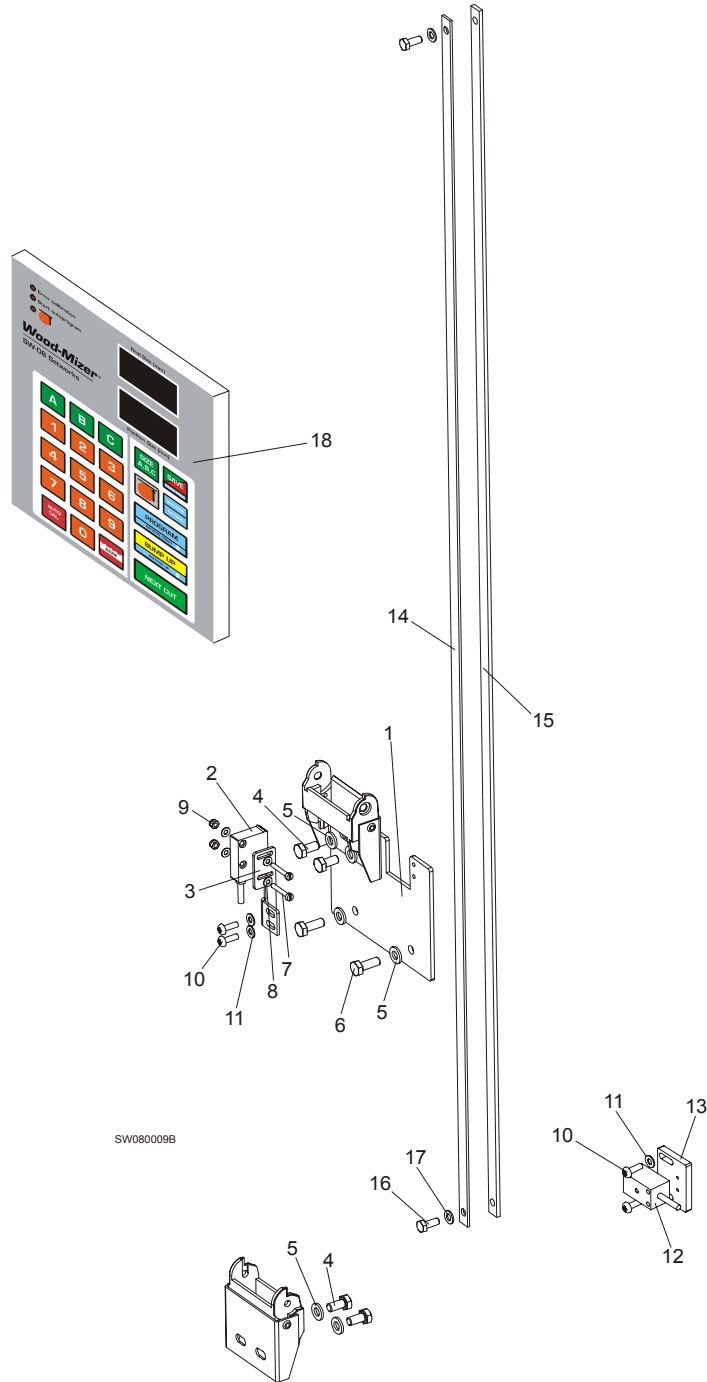

REF	DESCRIPTION (◆ Indicates Parts Available In Assemblies Only)	PART #	QTY.
	HARNESS GUIDE AND SENSOR ASSEMBLY	098052	1
1	Mounting Plate, Harness and Sensor assy.	096067-1	1
2	Sensor, MSK-320	096014	1
3	Bracket, Sensor Mount	096068-1	1

3

Replacement Parts*LT20 SW-08 Setworks*

4	Bolt, M6x12mm Hex Head zinc	F81001-7	4	
5	Washer, M6, Flat, zinc	F81053-1	6	
6	Bolt, M6x16-5.8	F81001-14	2	
7	Screw M3x20-5.8-A	F81000-8	2	
8	Washer 3,2	F81050-2	4	
9	Nut M3	F81028-2	2	
10	Screw M4x12 -5,8-B	F81011-43	4	
11	Washer 4,3	F81051-2	4	
12	Calibration Sensor	098051	1	
13	Plate, Mounting	099529-1	1	
	Harness Guide, SR300A 050 080	097924	1	
	MAGNETIC STRIP ASSY	097774	1	
	Bar with Magnetic Strip	098173-1	1	
14	Magnetic Strip MB320 (1m)	096014-1	1	
15	Bar, Magnetic Strip	098173	1	
16	Bolt, M5 X 12-5.8-Fe/Zn5	F81000-5	2	
17	Washer, M5, Flat zinc	F81052-1	2	
	MEMBRAN,E CONTROLLER SW08	083729	1	
18	CONTROLLER, SW-08 SETWORKS	100570	1	
	FRAME, SW08 SETWORKS REAR	100909	1	

3.4 LT40 SW-08 Setworks

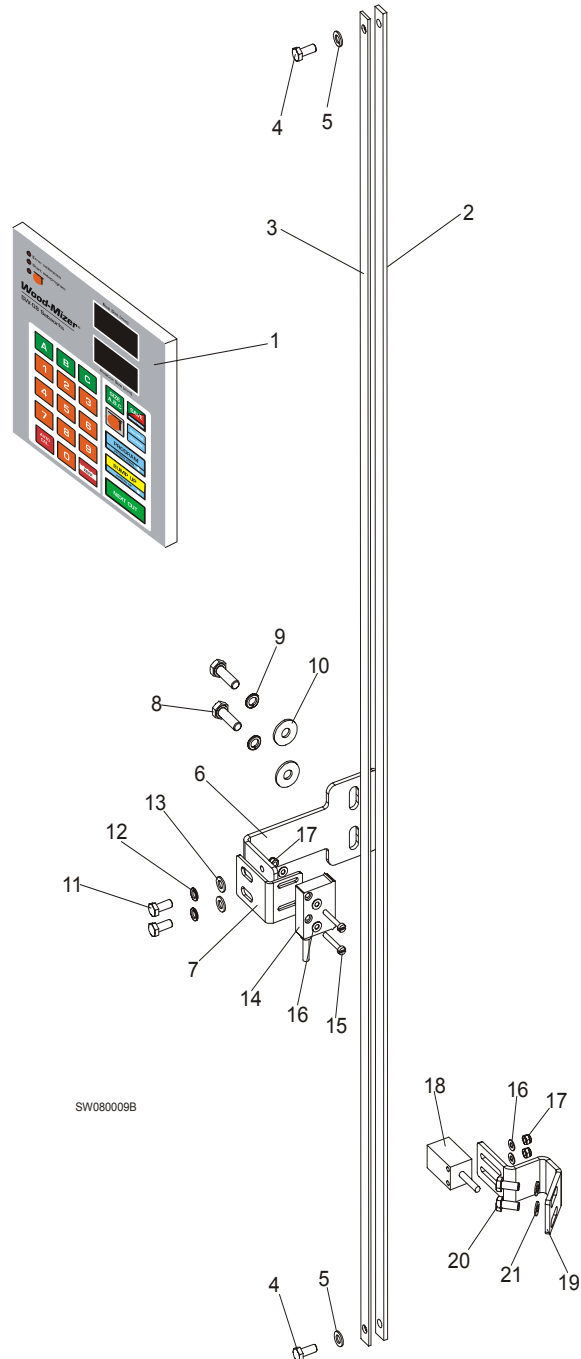

REF	DESCRIPTION (◆ Indicates Parts Available In Assemblies Only)	PART #	QTY.
1	CONTROLLER, SW-08 SETWORKS	100570	1
	FRAME, SW08 SETWORKS REAR	100909	1
	MEMBRANE, CONTROLLER SW08	083729	1
	MAGNETIC STRIP ASSY	097774	1
	Bar with Magnetic Strip	098173-1	1

3

Replacement Parts

LT40 SW-08 Setworks

2	Magnetic Strip MB320 (1m)	096014-1	1	
3	Bar, Magnetic Strip	098173	1	
4	Bolt, M5 X 12-5.8-Fe/Zn5	F81000-5	2	
5	Washer, M5, Flat zinc	F81052-1	2	
	BRACKET, SENSOR COMPLETE	100620	1	
6	Bracket, Sensor	100599-1	1	
7	Bracket, Sensor	100619-1	1	
8	Bolt, M6x20-8.8 Hex Head Full Thread Zinc	F81001-2	2	
9	Washer, Z6.1 Split Lock Zinc	F81053-3	2	
10	Washer, 6.5 Flat Zinc	F81053-11	2	
11	Bolt, M5 X 12-5.8-Fe/Zn5, PN-M/82105	F81000-5	2	
12	Washer, 5.1 Split Lock Zinc	F81052-2	2	
13	Washer, 5.3 Flat Zinc	F81052-1	2	
14	SENSOR, MSK-320	096014	1	
15	BOLT, M3 x 20-5.8-A-Fe/Zn8, PN-85/M-82215	F81000-8	2	
16	WASHER, 3.2 FLAT ZINC	F81050-2	6	
17	NUT, M3-6-FE/ZN5 PN-85/M-82175	F81028-2	4	
18	SENSOR, SW08 CALIBRATION	098051	1	
19	BRACKET, SW08 SENSOR	099313-1	1	
20	BOLT, M5 X 12-5.8-FE/ZN5, PN-M/82105	F81000-5	2	
21	WASHER, 5.1 SPLIT LOCK ZINC	F81052-2	2	