



user manual

Instrukcja obsługi | Руководство пользователя
Manuel de l'Utilisateur | Betriebsanweisung
Bruksanvisning | Manual del Usuario
Betjeningsvejledning | Gebruikershandleiding
Käyttöohjeet | Manual de utilizare | Bruksanvisning
Manuale d'uso | Příručka uživatele

Retain for future use
Zachować do przyszłego użytku
Сохраните для последующего
использования
A conserver pour une utilisation future
Für zukünftige Benutzung aufbewahren
Behold for senere bruk
Säilytä nämä käyttöohjeet tulevaa tarvetta marten
Opbevar manualen til fremtidig brug
Bewaren voor gebruik in de toekomst
Conservare il presente manuale a l'uso futuro
Păstrați acest manual pentru utilizare viitoare
Conservar para futuras consultas
Behall för framtida användning
Uchovejte pro další použití

SW-07 NETWORKS

Operation & Parts Manual

LT20 SW-07 Setworks
LT40 SW-07 Setworks

rev.B.00
rev. B.00



Safety is our #1 concern! Read and understand all safety information and instructions before operating, setting up or maintaining this machine.

April 2007

Form #641

Table of Contents

Section-Page

SECTION 1	OPERATION	2-1
1.1	SW-07 Controller Panel	2-1
1.2	Start-up settings of the controller	2-3
1.3	Operation in normal mode.....	2-7
1.4	Controller operation in pre-determined head return height mode	2-8
1.5	Pattern Mode	2-10
SECTION 3	TROUBLESHOOTING GUIDE	3-1
3.1	Setworks Malfunction	3-1
SECTION 4	ELECTRICAL INFORMATION	4-1
4.1	SW-07 Electrical Diagram connections on the LT20 AC sawmills.....	4-1
4.2	SW-07 Electrical Diagram connections on the LT20 DC sawmills.....	4-2
4.3	SW-07 Electrical Diagram connections on the LT40AC sawmills.....	4-3
4.4	SW-07 Electrical Diagram connections on the LT40DC sawmills.....	4-4
SECTION 5	REPLACEMENT PARTS	5-1
5.1	How To Use The Parts List	5-1
5.2	Sample Assembly	5-1
5.3	SW-07 Setworks.....	5-2

SECTION 1 OPERATION

1.1 SW-07 Controller Panel

See Pic. 1-1.

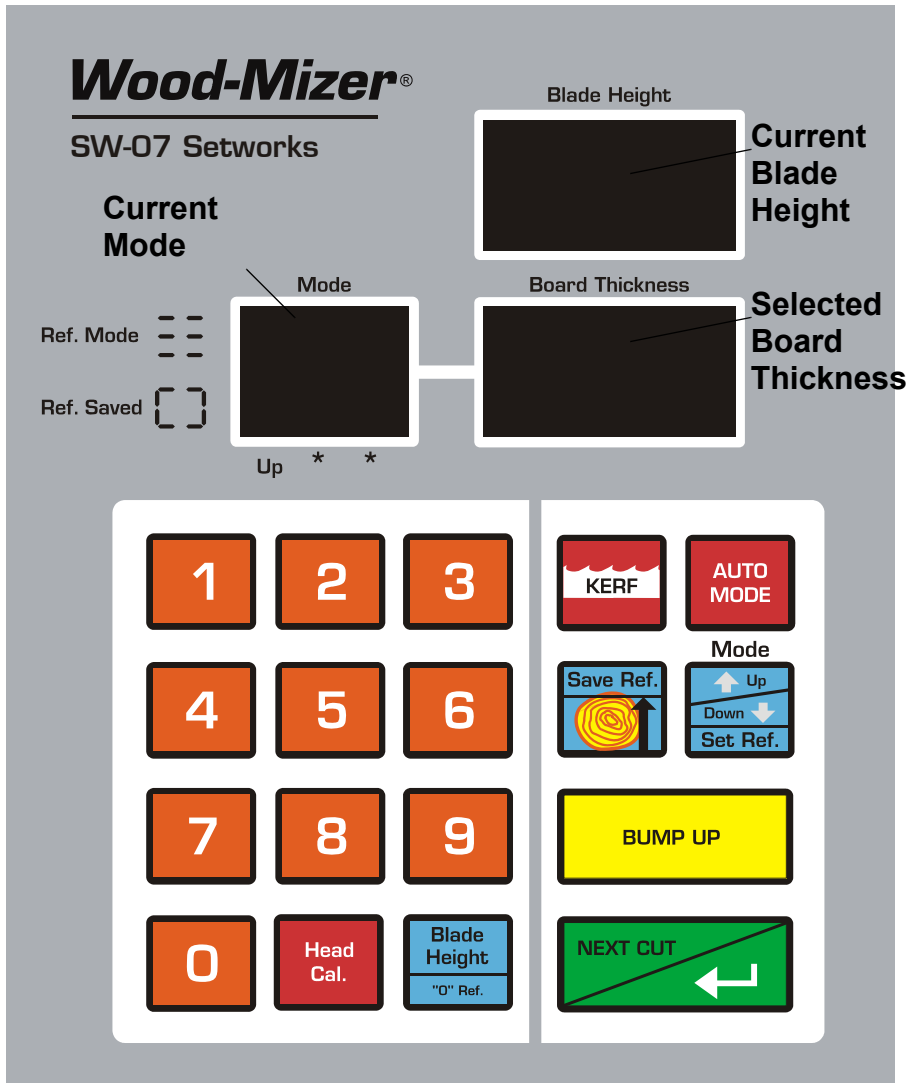

PIC. 1-1

1 OPERATION

SW-07 Controller Panel

Descriptions of the control panel buttons:



KERF – Setting the kerf.



Auto Mode – Adjustment of the SW-07 automatic calibration parameters. Used for initial calibration and re-calibration if dimensional error occurs.



Save Ref. - Saves Reference Height determined by operator.

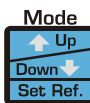

Mode - Mode selection.



BUMP UP - Bump Up. Last cut position after bump up.



NEXT CUT/← – The saw head automatically moves down to the next cut or the button acts as a “Save” or “Enter” button.





Head Cal. - Saw head height calibration.



Shows the actual input divider setting.

1.2 Start-up settings of the controller

1. Setting the input divider (entered only once, at the first start-up)

- Switch on the controller.
- When the text “ISP-07” appears on the display, press and hold , until the divider value appears on the lower right display.
- Enter the correct value of the divider (depending on the screw pitch of the machine) using keypad (for LT15 sawmills, the divider value should be **20**, for LT20 and LT40 sawmills, the divider value should be **5**).
- Press  to save the entered divider value - the text “**SAV**” will be appear.

To check the input divider setting, press and hold .

2. Entering the blade kerf thickness

On initial start-up or after replacement of the blade by another one with a different thickness or different tooth set the kerf value should be entered.

- Press and hold , until the small zero and current kerf settings appear on the lower right display.
- Enter the kerf value.

NOTE: We recommend using the Wood-Mizer blades only. For the Wood-Mizer blades, the kerf value should be 2mm, so you should press “2” and “0” buttons.

SW-07 Setworks can accept kerf value with an accuracy of 0,1 mm.

1 OPERATION

Start-up settings of the controller

See Pic. 1-2.

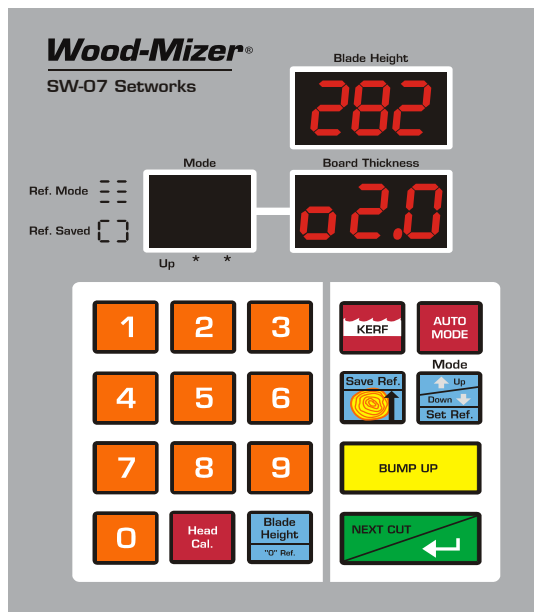

PIC. 1-2

- Press , to save the setting. The controller displays the text “SAV” and exits the function.

NOTE: From this moment the Networks controller will be calculating the cutting position using the kerf value. Therefore, it is not necessary to correct head height manually during cutting.

3. Auto-correction

This function should also be used in case of:

- [LT15 sawmills] Replacement of the up-down system screw, motor or after lubrication of the screws and other moving elements of the head or when significant cutting variances are observed;

- [LT20 and LT40 sawmills] If the divergence between the blade height showing on the upper display and the real dimension from the bed rail level is observed.

- Switch on the controller and wait until the text “ISP-07” disappears.
- Set the head with the blade at a height of 150-200 mm.

- Press and hold down . After a while - the text “Aut” will appear on the display. The controller is ready for auto-correction.

See Pic. 1-3.

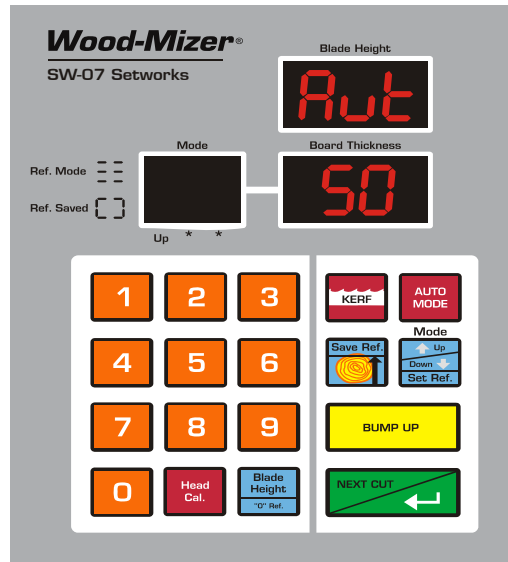

PIC. 1-3

- Press , the controller successively performs 2 downward movements of the head and then, 8 upward movements. After performing the last upward movement, the end of the function is signalled and the normal mode of operation is restored.

NOTE: If, during the downward movement, the lower limit switch is activated, set the head a little higher than previously and repeat the auto-correction function.

1 OPERATION

Start-up settings of the controller

4. Calibrating the blade height measurement

- In order to make the upper display show the real dimension from the level of the bed rail, set the head with blade at any height so that it is at a full millimeter (e.g. 200 mm); for this purpose you can use the sawmill scale, or you can measure blade height from the bed rail with the use of a ruler or tape measure.
- Press and hold **Head Cal.**, and after a while, 3 horizontal bars will appear on the upper display, while on the lower one - the previous measurement.

See Pic. 1-4.

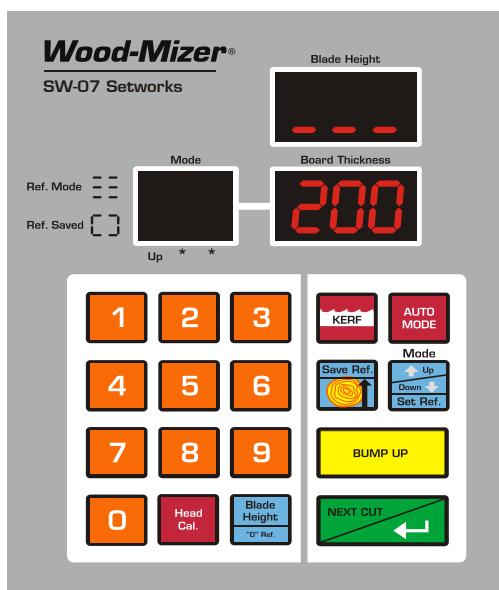

PIC. 1-4

- Enter the measured height using the keypad and confirm it by pressing **NEXT CUT**. The controller displays the text "**SAV**" and, after a while, it exits the function. The dimension of the real blade height, entered by you, appears in the upper display.

If the machine is not adjusted mechanically, while the power supply to the controller is off, then there is no need, as a rule, to calibrate the height after switching on (the head height is stored in the controller memory). Re-calibration should be performed, if any divergences in readings are found, or if during operation, for example, a break in the power supply occurred and the controller did not store the head height.





WARNING! Entering the real value of the height is

necessary for correct operation of the controller.

1.3 Operation in normal mode

 **CAUTION!** The minimum thickness of the last board (when using automatic modes) cannot be lower than **30 mm** [LT15 and LT20 sawmills] and **50mm** [LT40 sawmill]. To cut thinner board you need to manually lower the saw head.

After switching-on, the ISP-07 inscription appears in the display, and the networks is ready for operation within a few seconds or after  is pressed. The last used board thickness is displayed.

- To change the board thickness, enter the new thickness required using the keypad. The board thickness will be stored to the controller memory automatically. Press . Saw head will move down by the pre-set value (board thickness + kerf).

See Pic. 1-5.

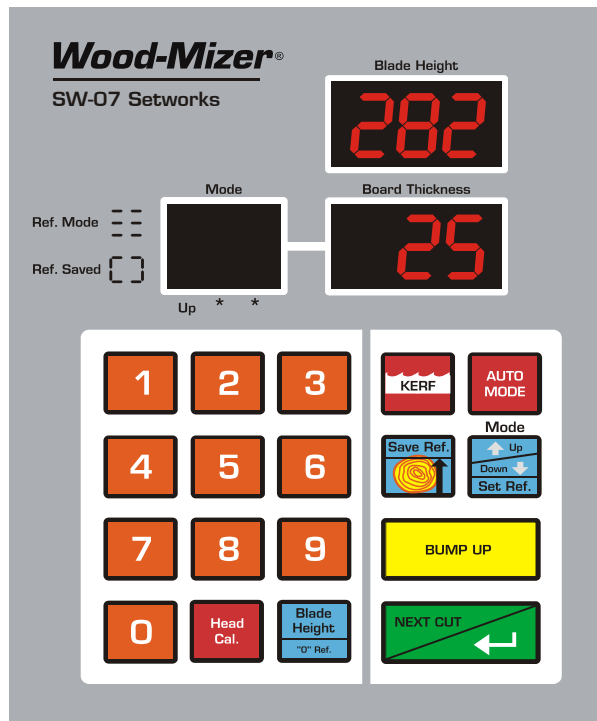

PIC. 1-5

- Start to cut material of required dimension.

1

OPERATION

Controller operation in pre-determined head return height mode

- Remove the board.
- Having completed a cut, press , the head will automatically go up by the pre-set bump up dimension, allowing the head to return with the blade clear of the log or cant.

NOTE: If you need to move the saw head to **the previous cut position**, press .

- Press  again and the saw head will drop by the pre-set board thickness to **the next cut position**.

The first cut position has to be set manually.

NOTE: After you set the first cut position you do not need to manually set the head height.

1.4 Controller operation in pre-determined head return height mode

It is possible to set a pre-determined head return height. This is particularly useful if you are cutting “through and through” and do not want to remove each board as you cut it.



Pre-setting a fixed head return height:

- Position the head above the cant or log so that it will clear the cant.
- Press and hold , until 3 horizontal bars appear on the left-hand display.

See Pic. 1-6.



PIC. 1-6

- Enter the board thickness and press .
- Now, when you press  at the end of each cut, the head will go up to the saved height and clear the cant or log.
- Press  to return to normal Bump Up operation.



1 OPERATION

Pattern Mode

1.5 Pattern Mode

Use this function when you want to receive a particular size of cant and boards of various dimensions.

Position the head at the required final cant dimension (e.g. 200).



Press  once – two zeros will appear on the left-hand display indicating that you can enter the first board dimension. Next, when you press , the head will go up the preset board dimension and the display will show **01**, which means that the first board dimension has been stored. Enter other required board dimensions, confirming each dimension by pressing .



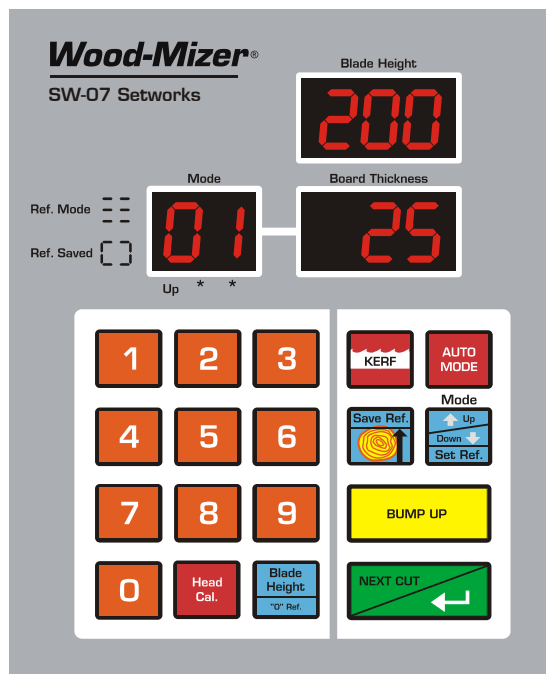

NOTE: The controller can store up to 30 board thickness values.



See Pic. 1-7.



PIC. 1-7

If you want to start cutting and remove each board after cutting, press  after you finished entering the required board dimensions. A “bracket” symbol will briefly appear on the left-hand display to indicate cutting without pre-determined head return height. Cut the first board and remove it. Press  and return the saw head. Cut the next boards. On the left-hand display following board numbers are shown until the **0!** board is reached. Additionally, **END** will be shown on the right-hand display to indicate the end of cutting. To exit the pattern mode, press .

If you are going to cut “through and through” and do not want to remove each board after cutting, enter the required board dimensions as in the first example and next position the head above the log so that it clears the log on the entire length. Press and hold  until 3 horizontal bars appear on the left-hand display. Next press , and the saw head will move to the first cut position and **Cut** will be shown on the right-hand display. Cut the first board. Press  and return the saw head without removing the board. Press  and cut the remaining boards until the **0!** board is reached. Additionally, **END** will be shown on the right-hand display to indicate the end of cutting. To exit this mode, press .

 **WARNING!** DO NOT press  while returning the saw head to the beginning of the log.







1

OPERATION

Pattern Mode

Example:

In this example we have a three sided cant and we want to finish with a 20cm x 20cm cant and have two boards - 50mm and 25mm. "Through and through" cutting will be described.

- Set the head to 20cm, carry out the procedure to change to Pattern mode, and enter the first board value 50mm and the second 25mm. Move the saw head up, to clear the cant . Press **and hold**  . Press  . The head will move to position "Cut 1" on the diagram.
- Cut the slab off the top of the cant. Press  .
- Return the head to the beginning of the cant.
- Press  , the head will move up to the "Cut 2" position ([See Pic. 2-9.](#)).
- Make a cut. Press  .
- Return the head.
- Press  , the head will drop down by the preset board thickness to the required 20cm cant dimension. **END** will be shown on the right-hand display.
- Having completed the cut, press  . Return the head to the beginning of the cant.

- Remove the boards

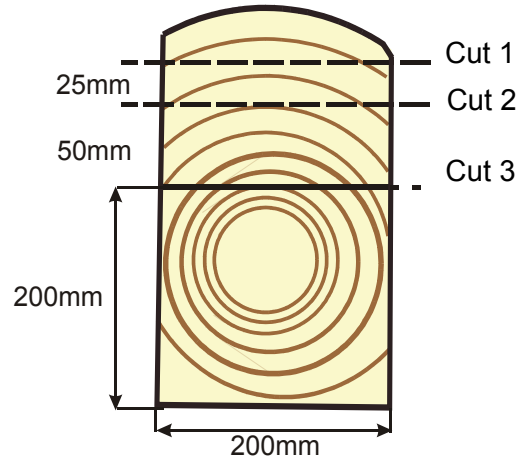

PIC. 1-8

SECTION 3 TROUBLESHOOTING GUIDE

3.1 Setworks Malfunction

PROBLEM	CAUSE	SOLUTION
Setworks does not work	Magnet sensor improperly aligned	Locate the magnet sensor and align it as shown on picture 3-2. Calibrate the blade-height measurement See Section Calibrating the blade height measurement.

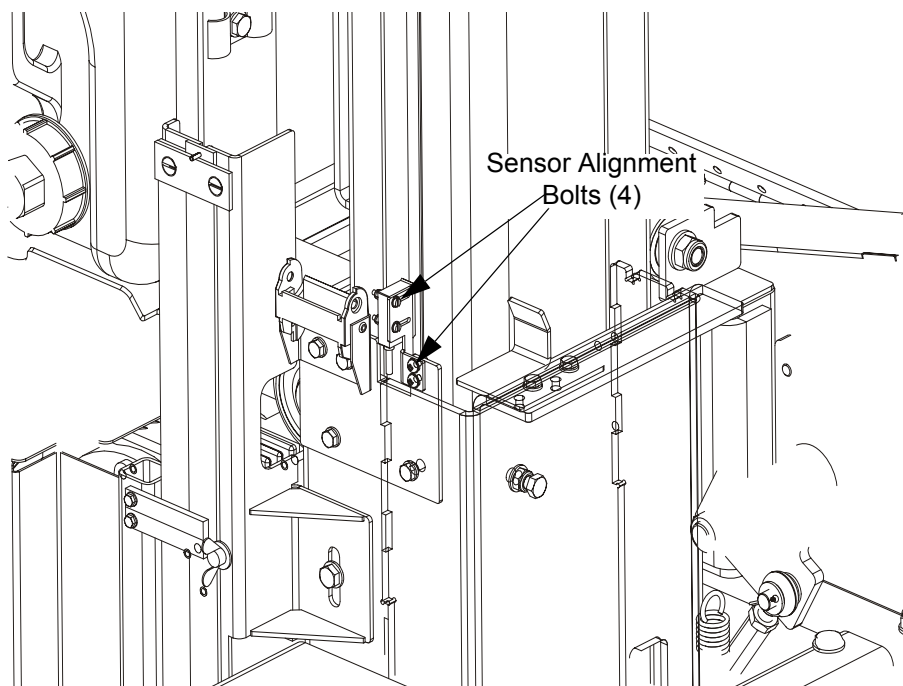

FIG. 3-1

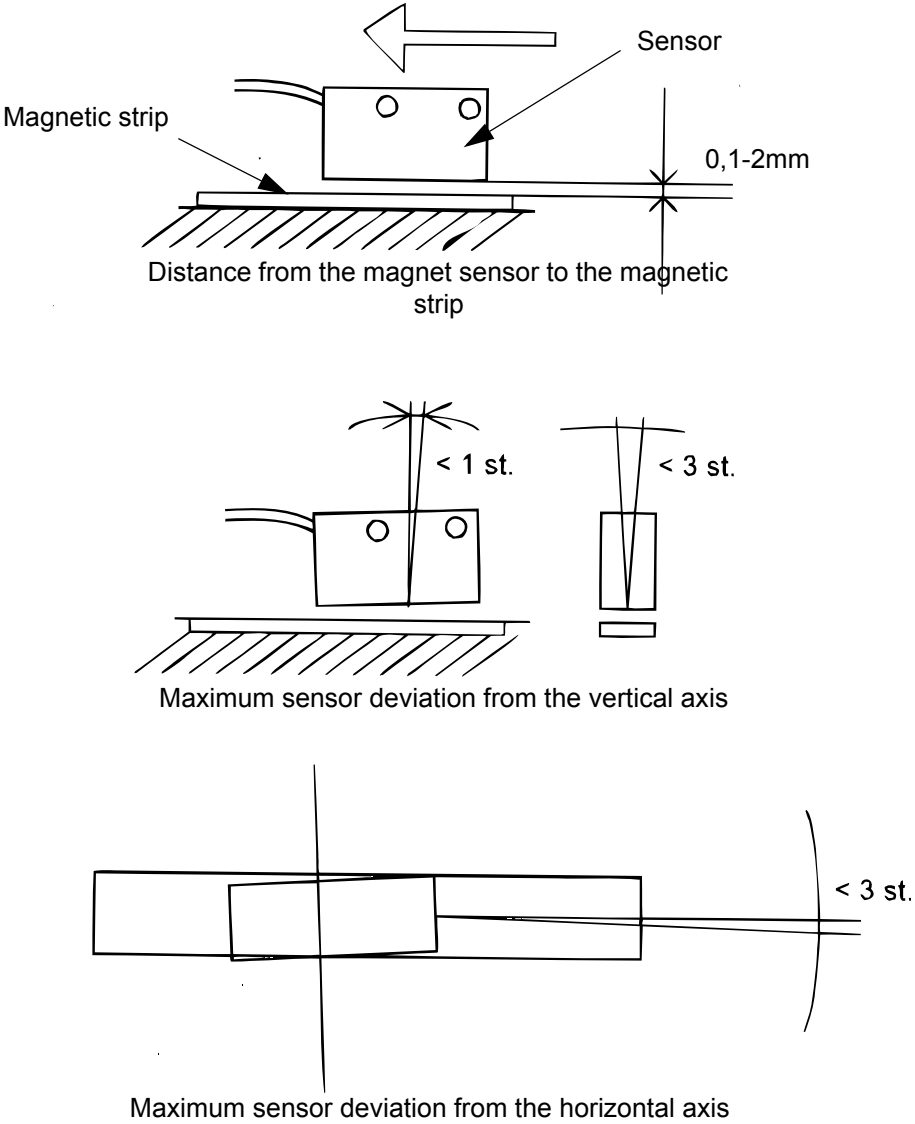
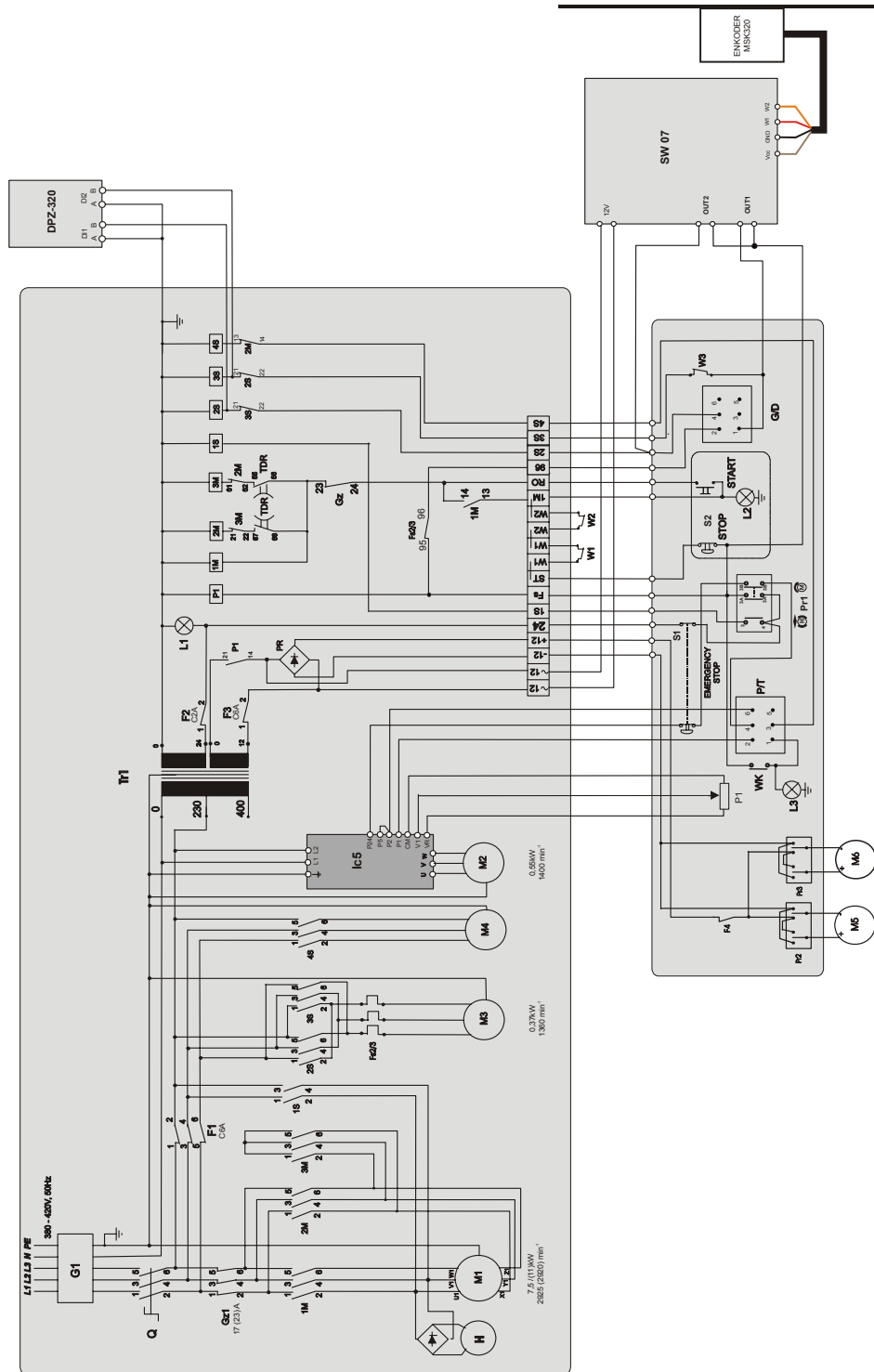

FIG. 3-2

SECTION 4 ELECTRICAL INFORMATION

4.1 SW-07 Electrical Diagram connections on the LT20 AC sawmills



RYS. 4-1

4.2 SW-07 Electrical Diagram connections on the LT20 DC sawmills

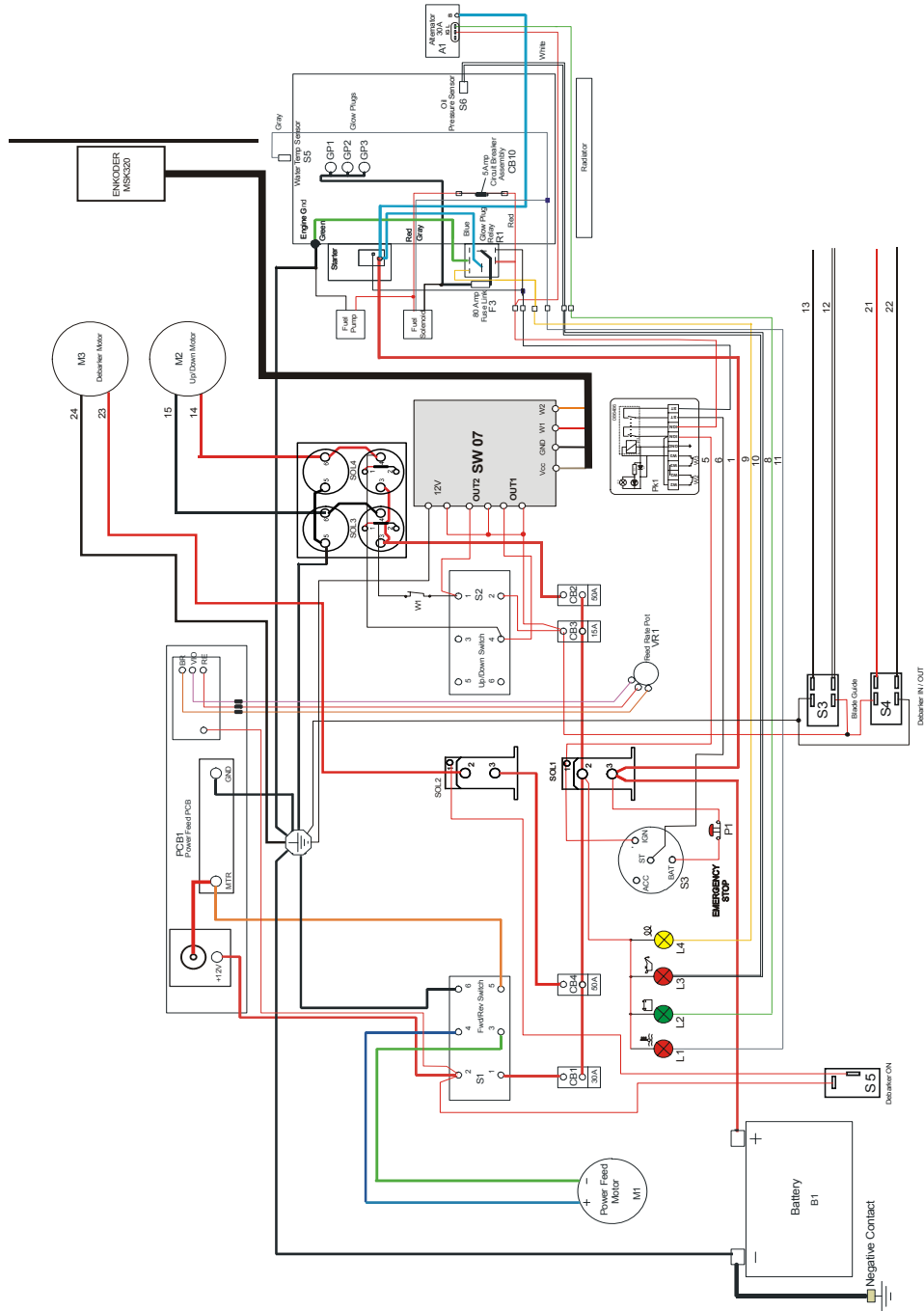

RYS. 4-2

4.3 SW-07 Electrical Diagram connections on the LT40AC sawmills

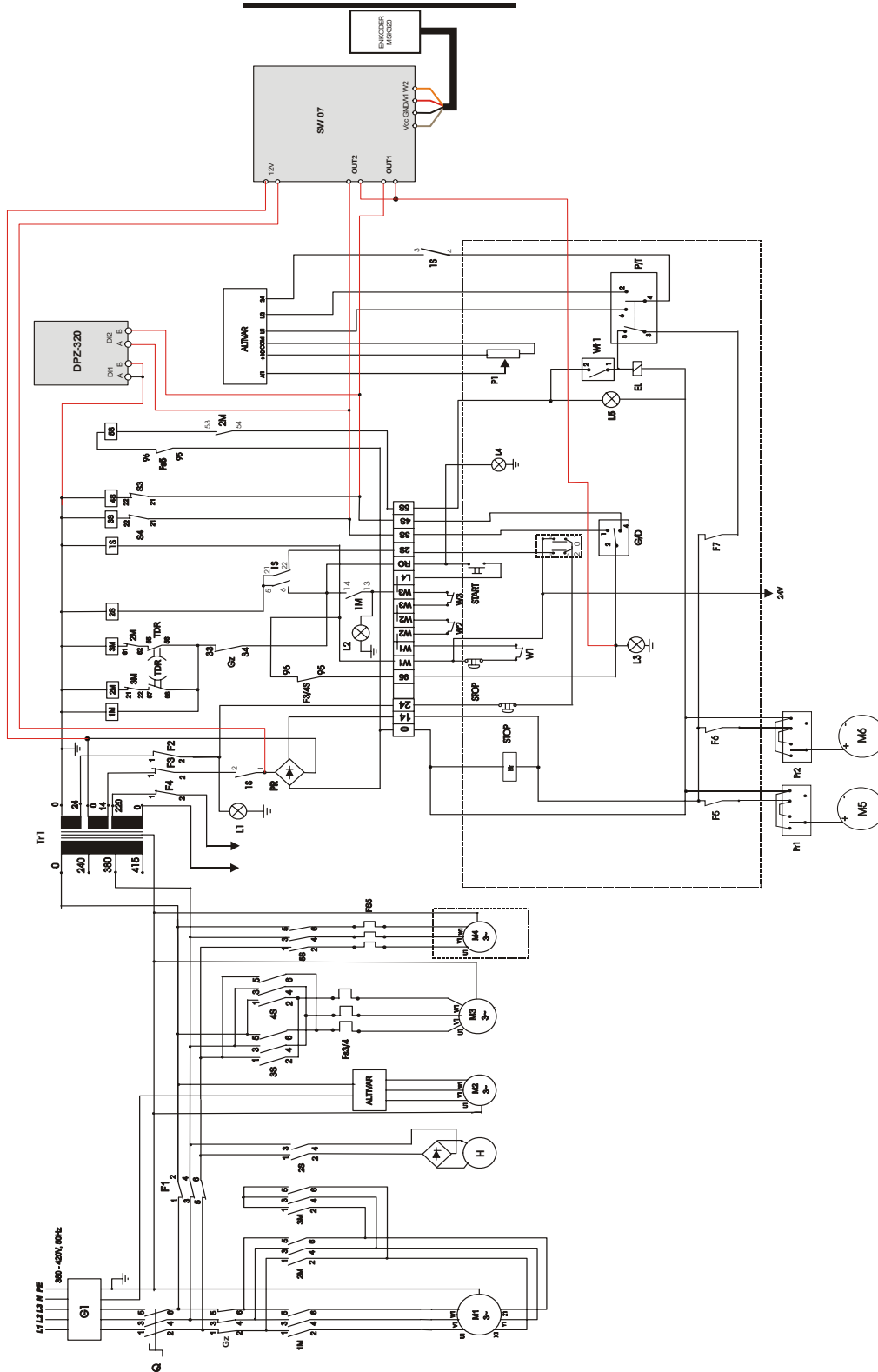

E15 Gz - 088264 (Gz1 M32)
E20-25 Gz - 090436 (Gv3 ME40)

4.4 SW-07 Electrical Diagram connections on the LT40DC sawmills

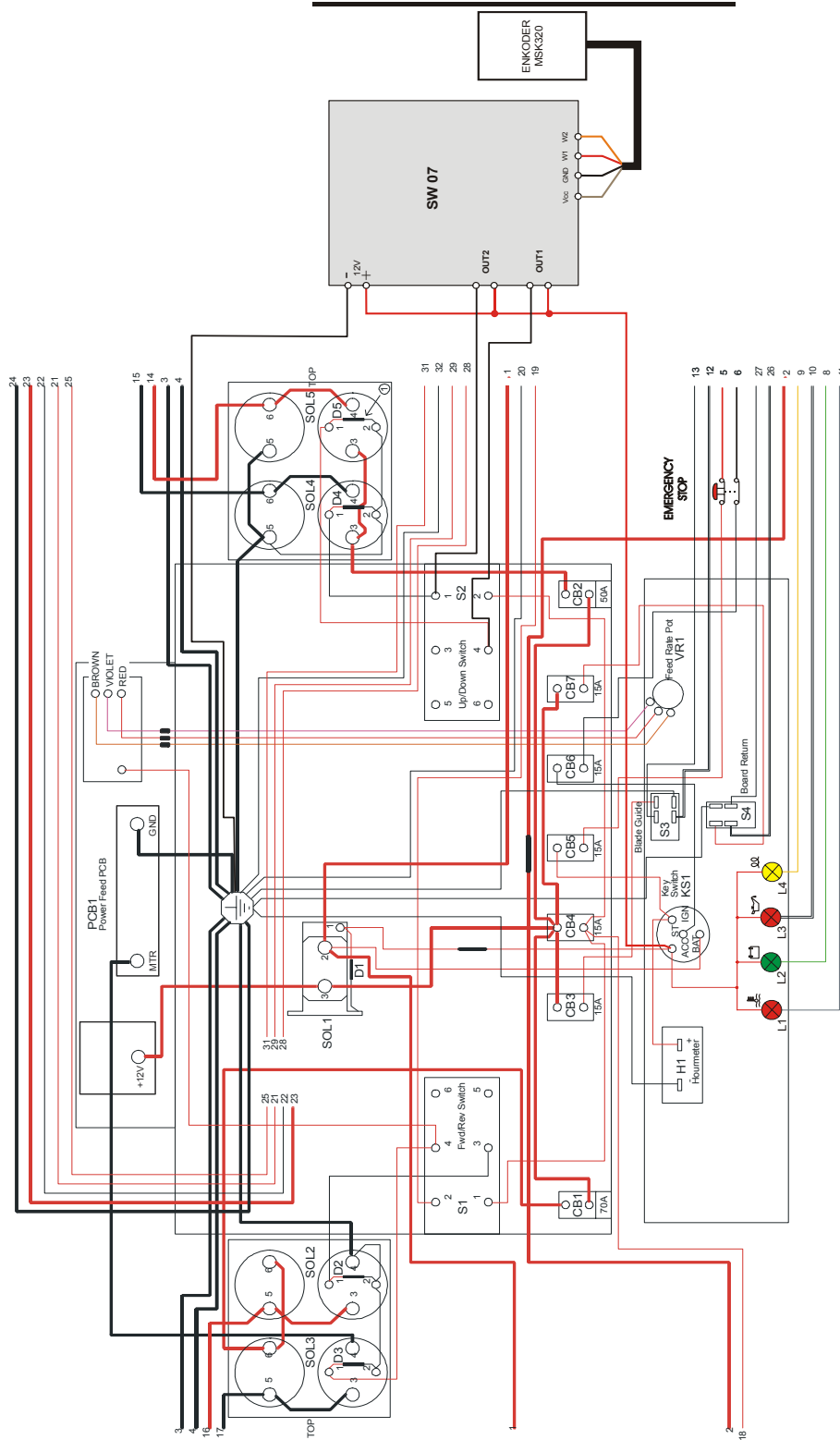

RYS. 4-4

SECTION 5 REPLACEMENT PARTS

5.1 How To Use The Parts List

- Use the index above to locate the assembly that contains the part you need.
- Go to the appropriate section and locate the part in the illustration.
- Use the number pointing to the part to locate the correct part number and description in the table.
- Parts shown indented under another part are included with that part.
- Parts marked with a diamond (◆) are only available in the assembly listed above the part.

See the sample table below. Sample Part #A01111 includes part F02222-2 and subassembly A03333. Subassembly A03333 includes part S04444-4 and subassembly K05555. The diamond (◆) indicates that S04444-4 is not available except in subassembly A03333. Subassembly K05555 includes parts M06666 and F07777-77. The diamond (◆) indicates M06666 is not available except in subassembly K05555.

5.2 Sample Assembly				
REF	DESCRIPTION (◆ Indicates Parts Available In Assemblies Only)	PART #	QTY.	
	Sample Assembly, Complete (Includes All Indented Parts Below)	A01111	1	
5	Sample Part	F02222-22	1	
	Sample Subassembly (Includes All Indented Parts Below)	A03333	1	
6	Sample Part (◆ Indicates Part Is Only Available With A03333)	S04444-4	1	◆
	Sample Subassembly (Includes All Indented Parts Below)	K05555	1	
7	Sample Part (◆ Indicates Part Is Only Available With K05555)	M06666	2	◆
8	Sample Part	F07777-77	1	

To Order Parts:

- From Europe call our European Headquarters and Manufacturing Facility in Kolo, Poland at **+48-63-2626000**. From the continental U.S., call our toll-free Parts hotline at **1-800-448-7881**. Have your customer number, vehicle identification number, and part numbers ready when you call.
- From other international locations, contact the Wood-Mizer distributor in your area for parts.

5.3 SW-07 Networks

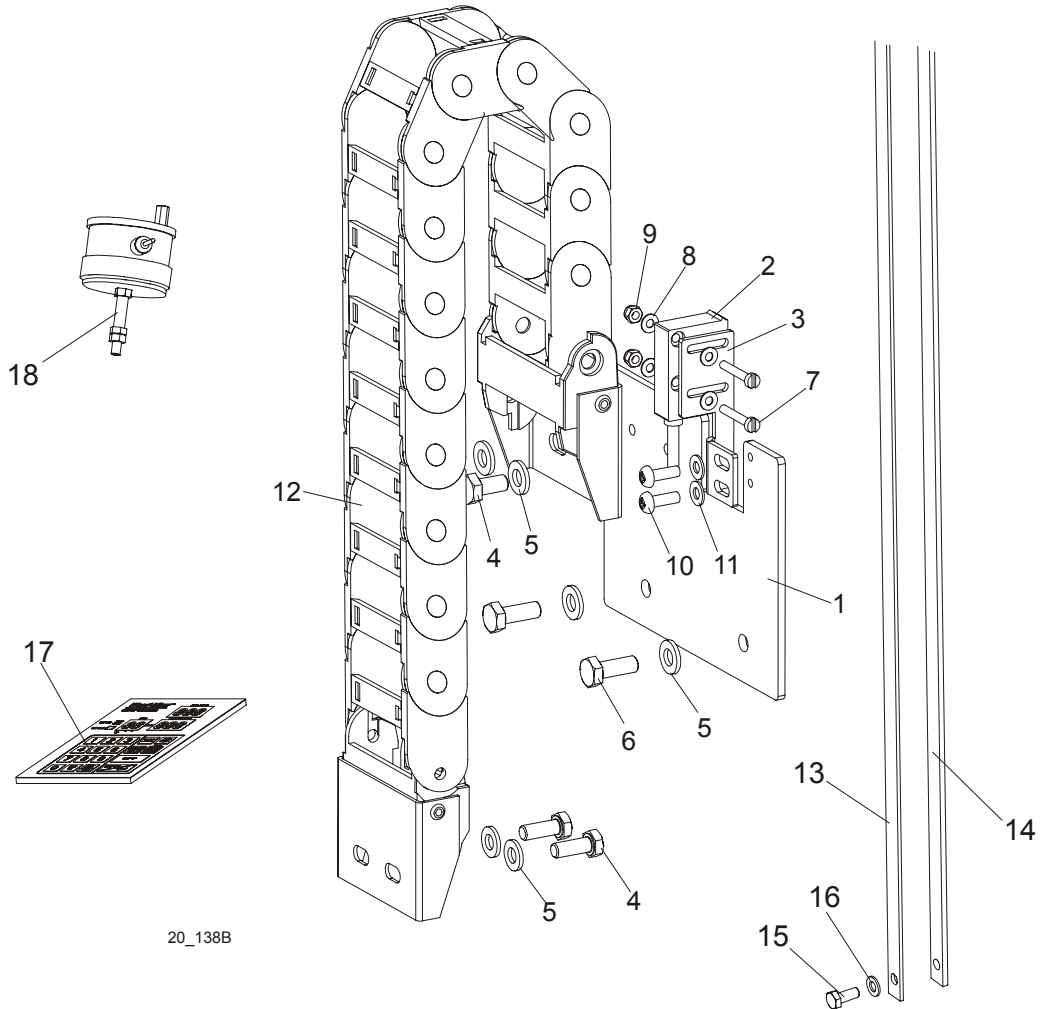

REF	DESCRIPTION (◆ Indicates Parts Available In Assemblies Only)	PART #	QTY.	
	HARNESS GUIDE AND SENSOR ASSEMBLY	098052	1	
1	Mounting Plate, Harness and Sensor assy.	096067-1	1	
2	Sensor, MSK-320	096014	1	
3	Bracket, Sensor Mount	096068-1	1	
4	Bolt, M6x12mm Hex Head zinc	F81001-7	4	
5	Washer, M6, Flat, zinc	F81053-1	6	
6	Bolt, M6x16-5.8	F81001-14	2	
7	Screw M3x20-5.8-A	F81000-8	2	
8	Washer 3,2	F81050-2	4	
9	Nut M3	F81028-2	2	
10	Screw M4x12 -5,8-B	F81011-43	2	
11	Washer 4,3	F81051-2	2	
12	Harness Guide, SR300A 050 080	097924 ¹	1	

4

Replacement Parts

SW-07 Setworks

	MAGNETIC STRIP ASSY	097774	1	
	Bar with Magnetic Strip	098173-1	1	
13	Magnetic Strip MB320 (1m)	096014-1	1	
14	Bar, Magnetic Strip	098173	1	
15	Bolt, M5 X 12-5.8-Fe/Zn5	F81000-5	2	
16	Washer, M5, Flat zinc	F81052-1	2	
	SW-07 SETWORKS W/ENCODER	095316	1	
17	Panel, SW-07 Setworks	098454	1	
18	Encoder, 50 imp./r.	096016	1	

¹ Applied to LT20 only.